



Montaažiskeem / Mounting Instructions / Монтажная схема

Renault T 2014-

Art. 862310 Art. 862320
Art. 862315 Art. 862325

Rammraud

Cattleguard

Передняя дуга



- | | |
|---|---|
| 1. Rammraud / cattleguard / передняя дуга | 1 |
| 2. Kronstein / bracet / кронштейн | 1 |
| 3. Kronstein / bracet / кронштейн | 1 |
| 4. Kronstein / bracet / кронштейн | 1 |
| 5. Kronstein / bracet / кронштейн | 1 |
| 6. Heebel / fork pin / штифт | 2 |
| 7. Ketas / disc / диск | 4 |
| 8*. T-polt / t-bolt / t-болт | 2 |
| 9*. T-polt / t-bolt / t-болт | 4 |
| 10. Polt / bolt / болт M12x30 mm | 4 |
| 11. Mutter / nut / гайка M10 DIN 934 | 6 |
| 12. Mutter / nut / гайка M12 DIN 985 | 4 |
| 13. Seib / washer / шайба 10,5x20x2 mm | 6 |
| 14. Seib / washer / шайба 13x24x2,5 mm | 2 |
| 15. Seib / washer / шайба 13x37x3 mm | 8 |
| 16. Vedruseib / spring washer / пружинная шайба A10 | 6 |
| 17. Vedrusplint / spring cotter / пружинная шплинт | 2 |

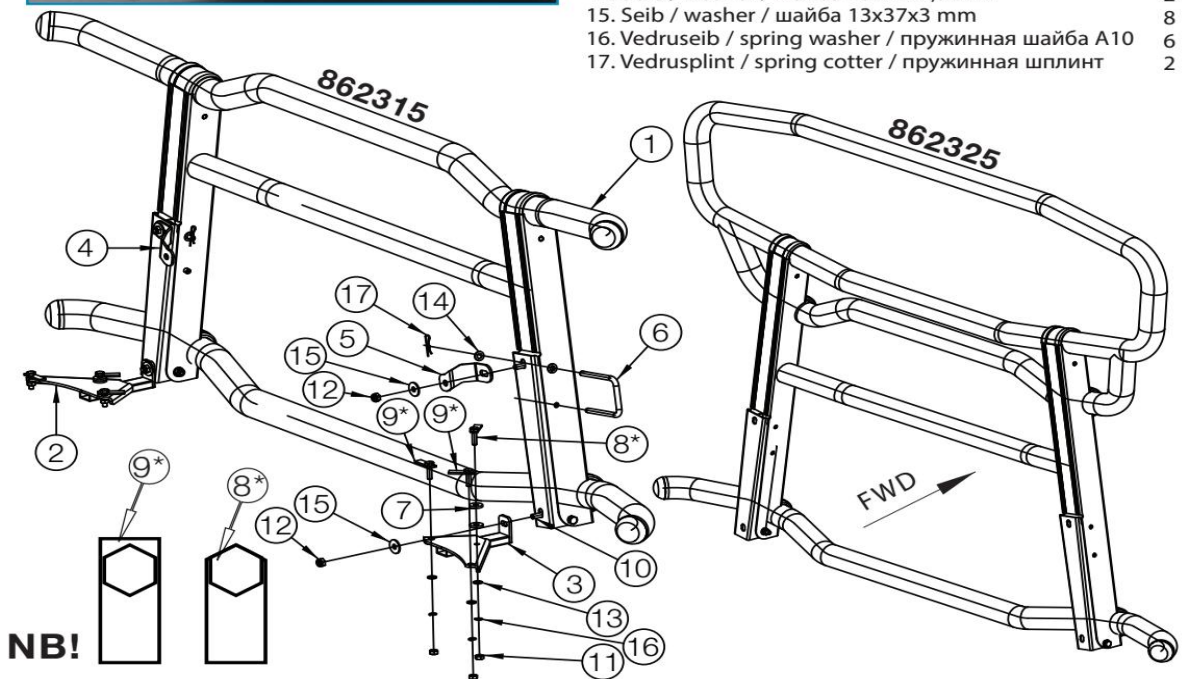

Vajalikud tööriistad / Required Tools / Необходимые инструменты



M10- 50Nm
M12- 90Nm

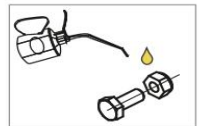



Pilt 1 / Pic. 1 / Рис. 1

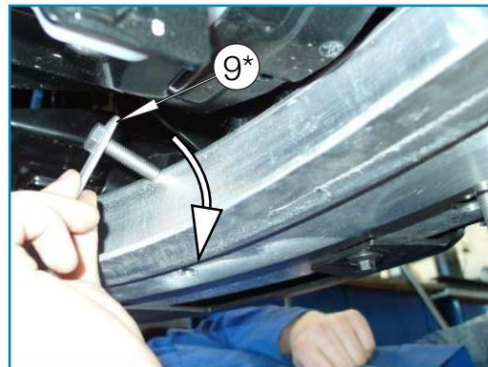

Pilt 2 / Pic. 2 / Рис. 2

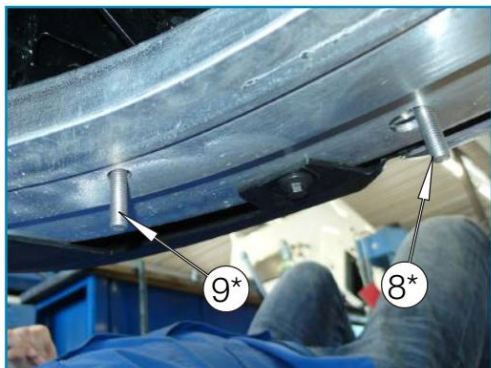

Pilt 3 / Pic. 3 / Рис. 3

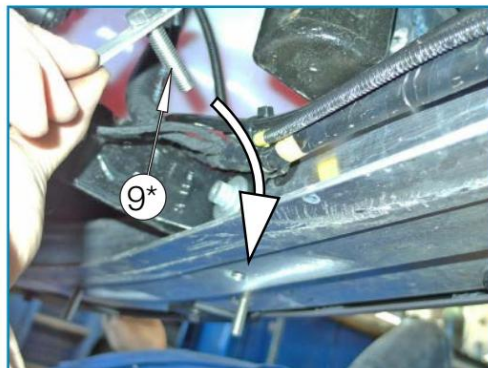

Pilt 4 / Pic. 4 / Рис. 4

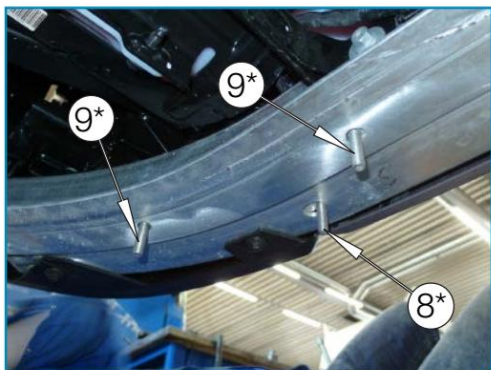

Pilt 5 / Pic. 5 / Рис. 5

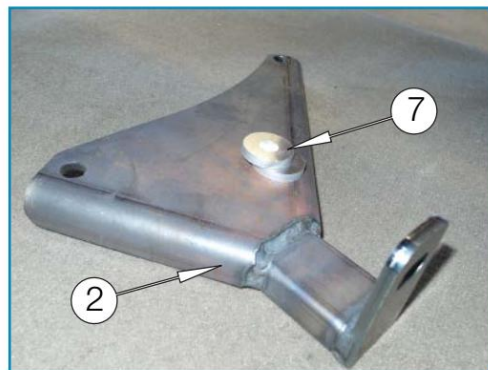

Pilt 6 / Pic. 6 / Рис. 6



Pilt 7 / Pic. 7 / Рис. 7



Pilt 8 / Pic. 8 / Рис. 8



Pilt 9 / Pic. 9 / Рис. 9



Pilt 10 / Pic. 10 / Рис. 10

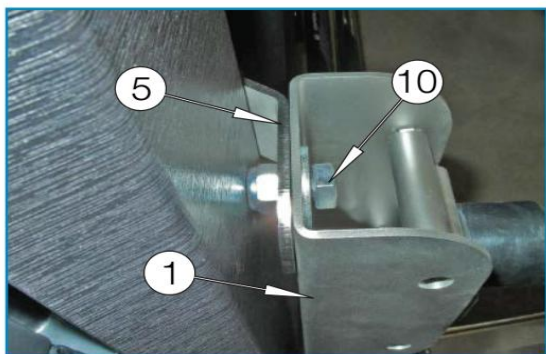

Pilt 11 / Pic. 11 / Рис. 11

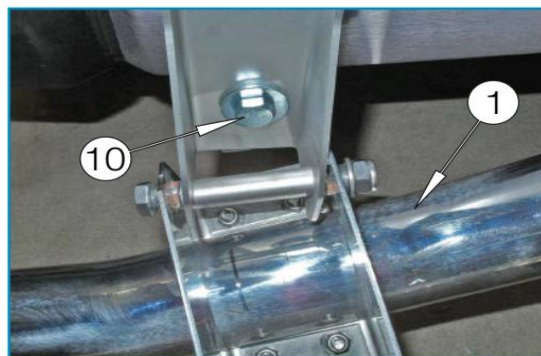

Pilt 12 / Pic. 12 / Рис. 12

