



Montaažiskeem / Mounting Instructions / Монтажная схема

ISUZU D-Max 2012-

Art. 813130

Põhjakaitse

Skid plate

Поддон



- | | |
|--|---|
| 1. Kaitse / skid plate / поддон | 1 |
| 2. Kronstein / bracket / кронштейн | 1 |
| 3. Tõmbemutter / rivet nut / гайка M10x13x20 | 2 |
| 4. Polt / bolt / болт M10x30 mm | 4 |
| 5. Polt / bolt / болт M10x70 mm | 2 |
| 6. Mutter / nut / гайка M10 DIN 985 | 2 |
| 7. Seib / washer / шайба 10,5x20x2 mm | 4 |
| 8. Seib / washer / шайба 10,5x30x2,5 mm | 4 |
| 9. Vedruseib / spring washer / пружинная шайба A10 | 4 |

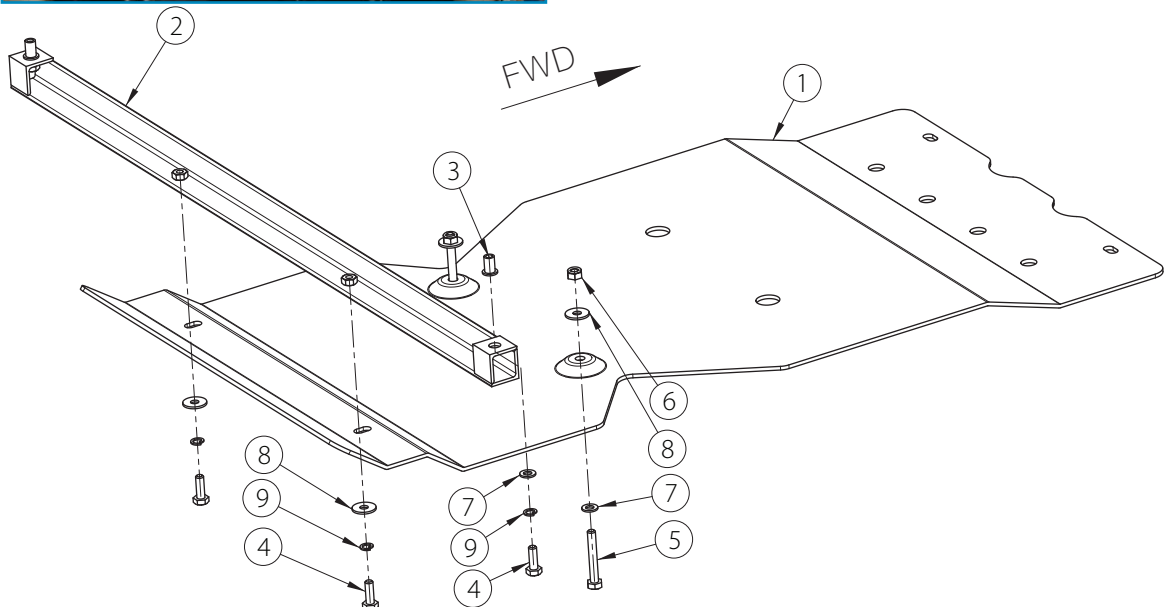

Vajalikud tööriistad / Required Tools / Необходимые инструменты



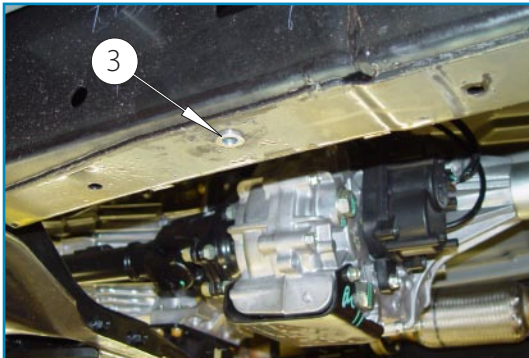

Pilt 1 / Pic. 1 / Рис. 1

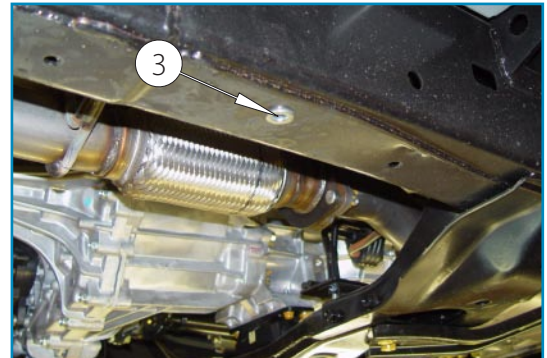

Pilt 2 / Pic. 2 / Рис. 2



Pilt 3 / Pic. 3 / Рис. 3

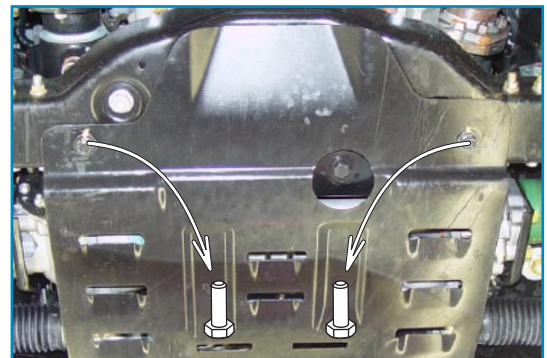

Pilt 4 / Pic. 4 / Рис. 4

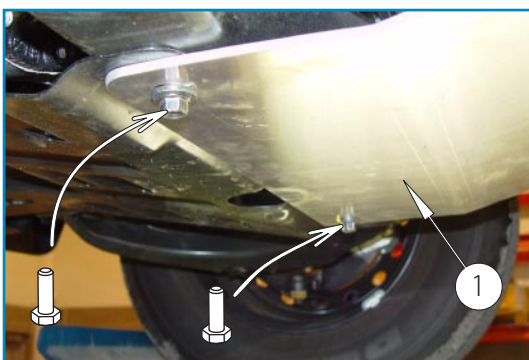

Pilt 5 / Pic. 5 / Рис. 5

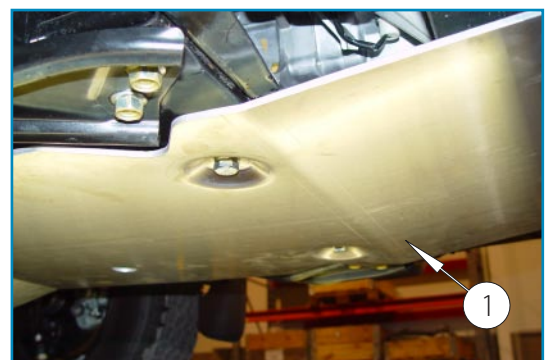

Pilt 6 / Pic. 6 / Рис. 6

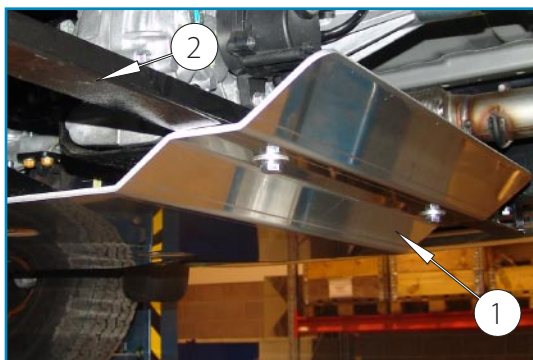

Pilt 7 / Pic. 7 / Рис. 7



Pilt 8 / Pic. 8 / Рис. 8

Toote andmed / Data of the product / Данные о товаре

- Mõõdud / Measures / Размеры: 620x75x1225 mm.
- Kaal / Weight / Масса: 13,3 Kg.
- Paigaldusaeg / Time of mounting / Время установки: 45 min.
- Tähtsad markeeringud / Important labels / Важные этикетки:

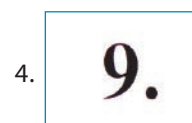

1. Komplekteerija number. / The number of the assembler / Номер комплектовщика
2. Tooteinfo pakendil / Product information on the package / Информация на упаковке
3. Tooteinfo tootel / Product information on the product / Информация на товаре
4. Kvaliteedi kontrolli tähis / Quality control number / Знак контроля качества