



Scania R 2016- (high cabin)

Art. 864660

Reelingud, külgmised | Railings, side | Перила, боковые | Geländer, Seite



- | | |
|--|----|
| 1. Look / arc / дуга / Bogen | 1 |
| 2. Look / arc / дуга / Bogen | 1 |
| 3. Look / arc / дуга / Bogen | 1 |
| 4. Look / arc / дуга / Bogen | 1 |
| 5. Polditav kronstein / bolt bracket / кронштейн / Bolzenhalterung | 8 |
| 6. Kronstein / bracket / кронштейн / Konsole | 1 |
| 7. Kronstein / bracket / кронштейн / Konsole | 1 |
| 8. Kronstein / bracket / кронштейн / Konsole | 1 |
| 9. Kronstein / bracket / кронштейн / Konsole | 1 |
| 10. Kronstein / bracket / кронштейн / Konsole | 2 |
| 11. Kronstein / bracket / кронштейн / Konsole | 1 |
| 12. Kronstein / bracket / кронштейн / Konsole | 1 |
| 13. Puks / bushing / букса / Buchse | 1 |
| 14. Polt / bolt / болт / Bolzen M6x35 | 3 |
| 15. Polt / bolt / болт / Bolzen M8x20 | 31 |
| 16. Polt / bolt / болт / Bolzen M8x60 | 1 |
| 17. Mutter / nut / гайка / Mutter M8 | 16 |
| 18. Seib / flat washer / шайба / Scheibe 6,4x18x1,6 | 3 |
| 19. Seib / flat washer / шайба / Scheibe 8,4x16x1,6 | 48 |
| 20. Vedruseib / spring washer / пружинная шайба / Federnscheibe A | 3 |
| 21. Vedruseib / spring washer / пружинная шайба / Federnscheibe A8 | 16 |
| 22. Juhtmesiduja / Cable tie /Стяжки для кабеля / Kabelbinder 98x25 mm | 10 |

NB!

1	2	3	4	5	6	7
8	9	10	11	12	13	14
15	16	17	18	19	20	21
22	23	24	25	26	27	28
29	30	31	32	33	34	35

2x

Elektriühendused teostada kvalifitseeritud autoelektriku poolt
Installation of the lights can be carried out by qualified electrician only

Монтаж огней может быть выполнено только квалифицированным электриком

Die Installation der Lichter können durchgeführt werden durch Elektrofachkraft

Külmkeevituse vältimiseks kasutada külmkeevitusvastast määret või mootoriõli.
To prevent cold welding, use cold weld grease or engine oil.
Verwenden Sie geeignetes Fett oder Motoröl, um die Kaltverschweißung zu verhindern.
Для предотвращения холодной сварки используйте смазку от холодной сварки или моторное масло.

Kaal / Weight / Масса / Gewicht: 17,3 kg
Paigaldusaeg ilma elektritöödeta / Time of mounting w/o wiring works / Время установки без электромонт. работ / Einbauzeit ohne elektrische arbeit: 60 min

Vajalikud tööriistad / Required Tools / Необходимые инструменты / Benötigte Werkzeuge



M6 - 11 Nm
M8 - 25 Nm



Scania R 2016- (high cabin)

Reelingud, külgmised | Railings, side | Перила, боковые | Geländer, Seite

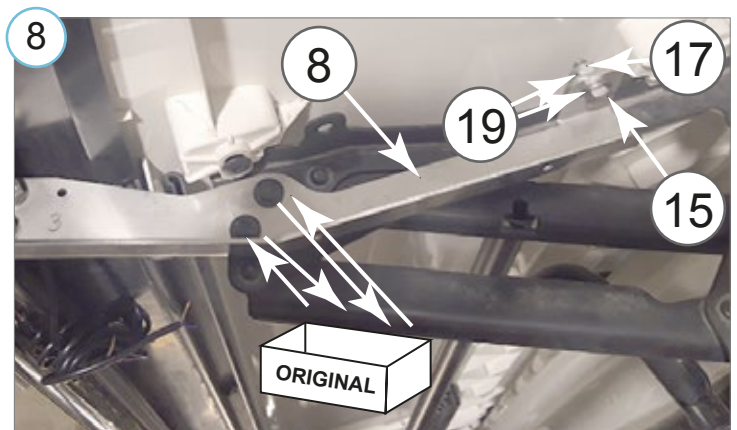
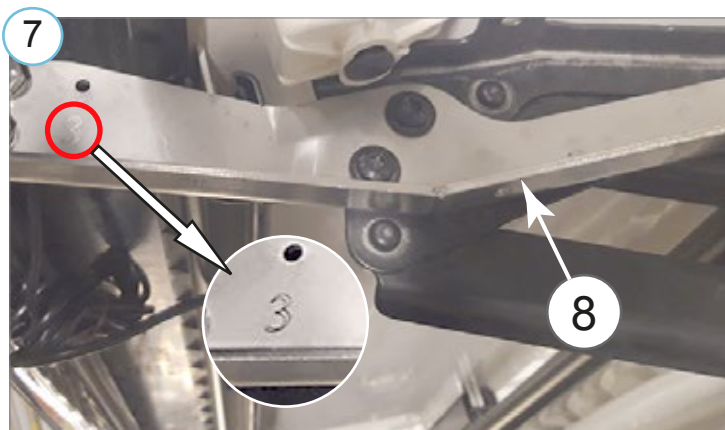
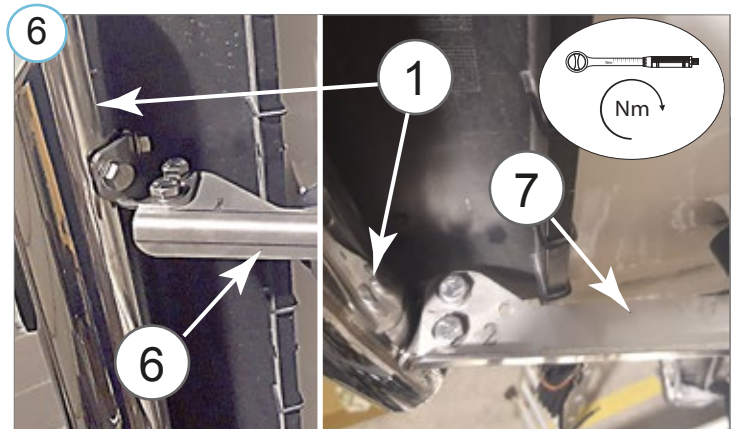
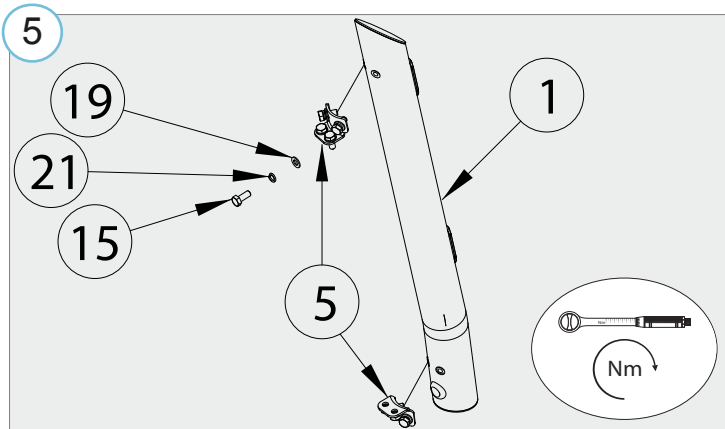
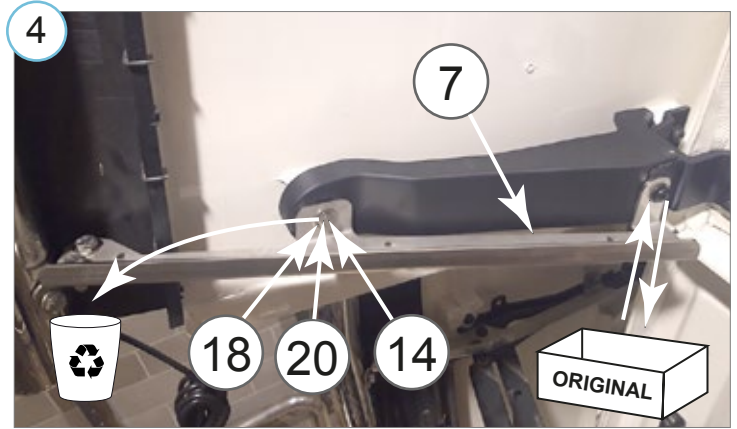
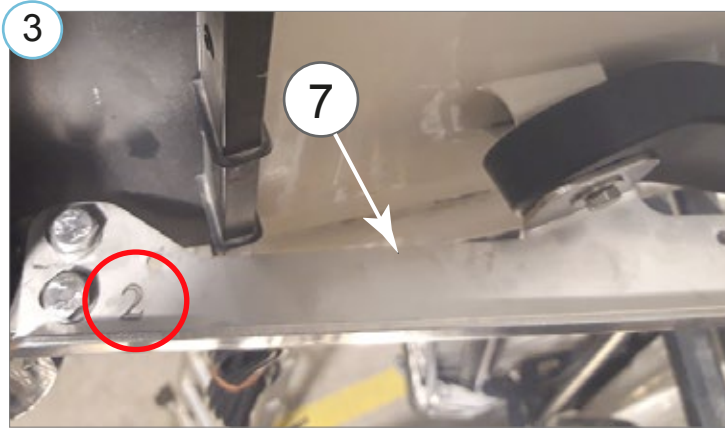
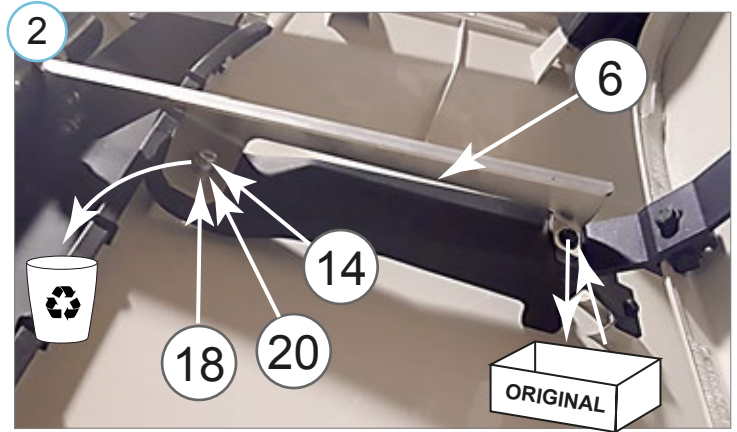
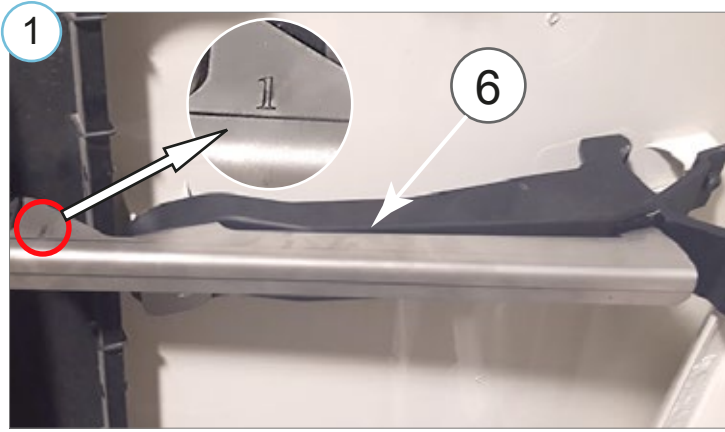

Scania R 2016- (high cabin)

Reelingud, külgmised | Railings, side | Перила, боковые | Geländer, Seite

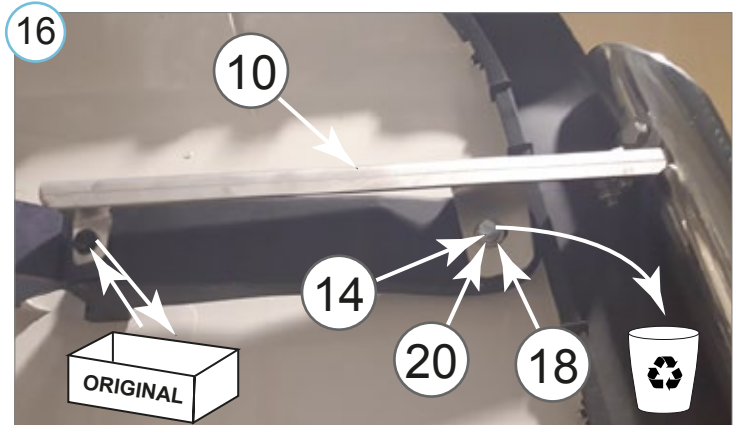
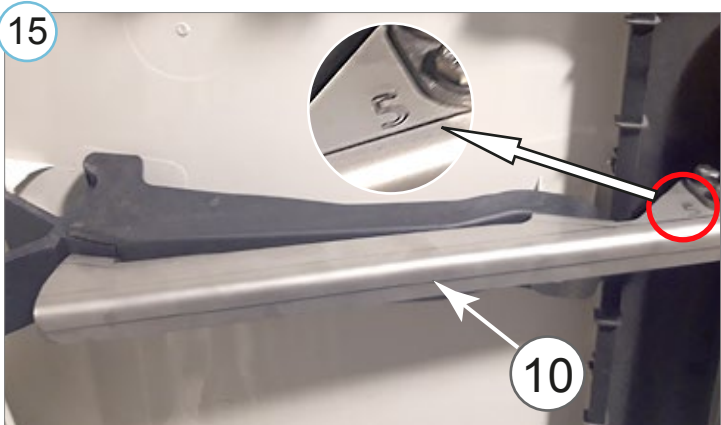
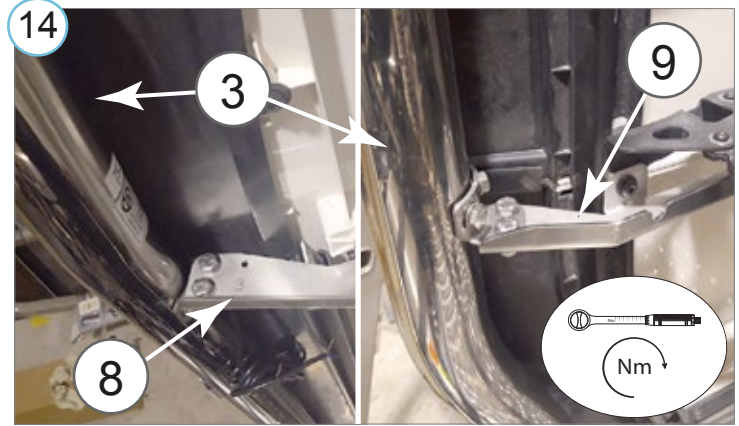
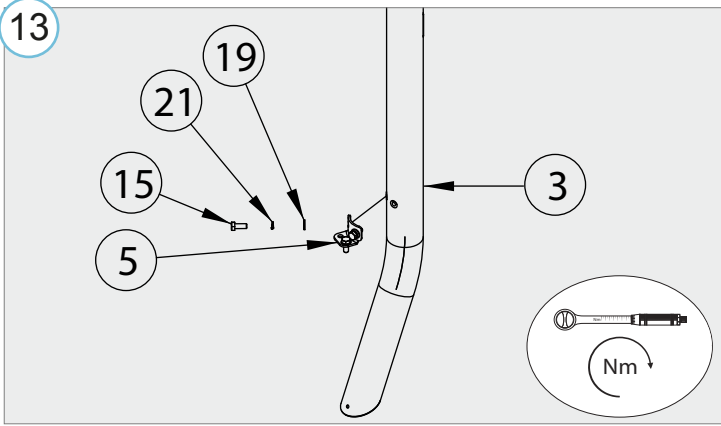
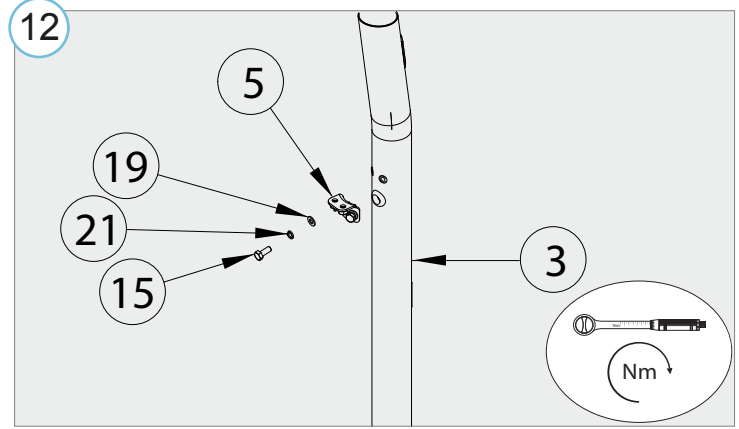
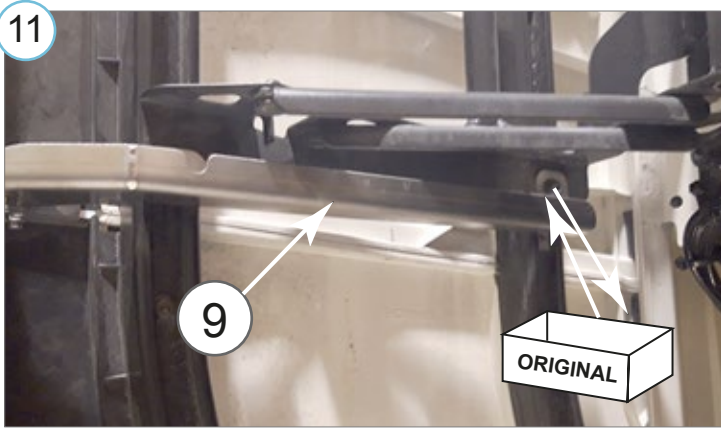
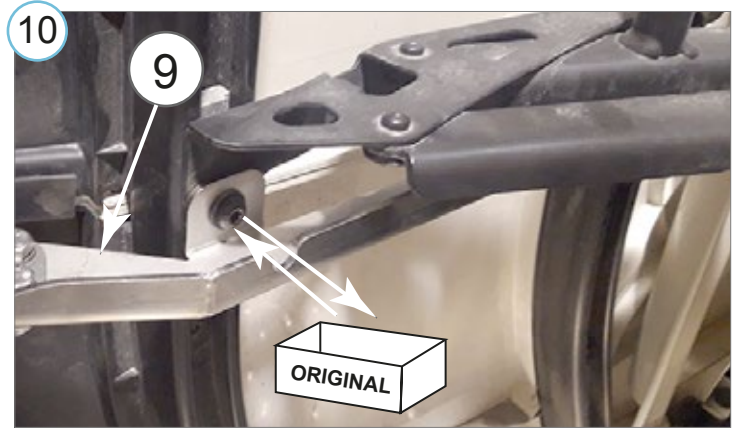
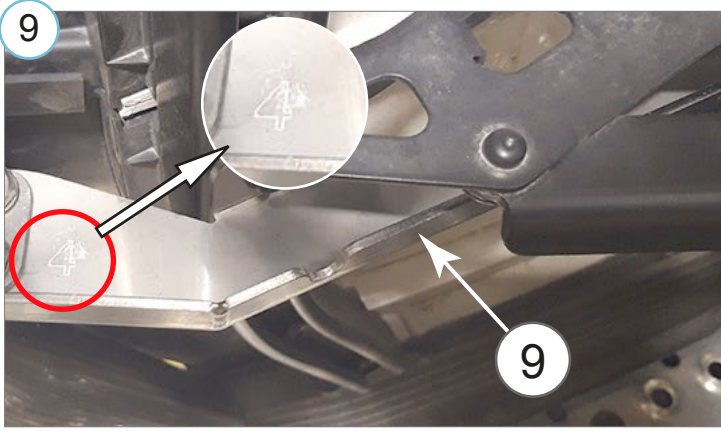

Scania R 2016- (high cabin)

Reelingud, külgmised | Railings, side | Перила, боковые | Geländer, Seite

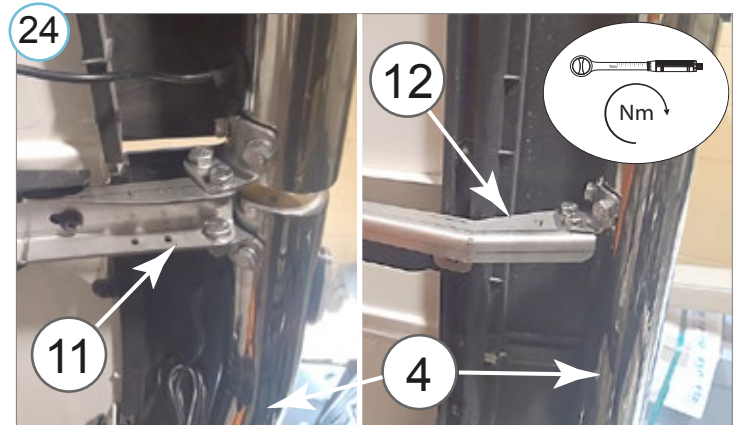
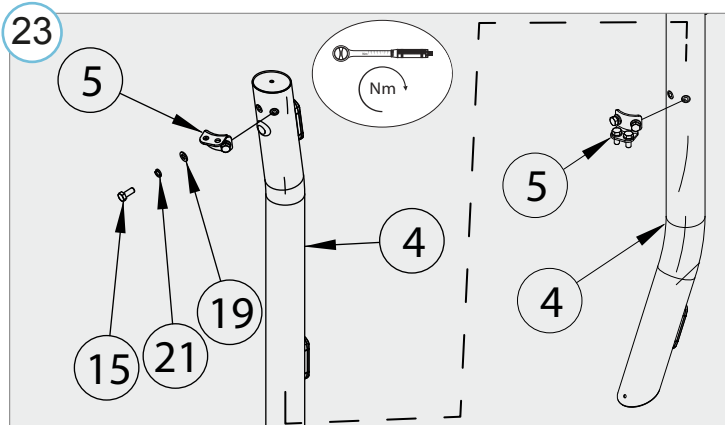
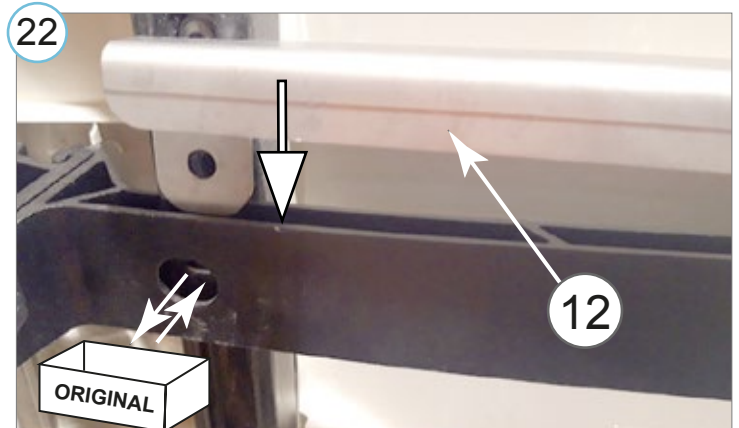
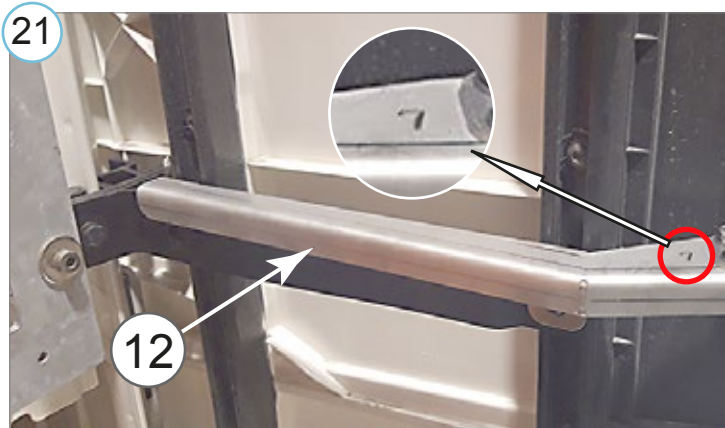
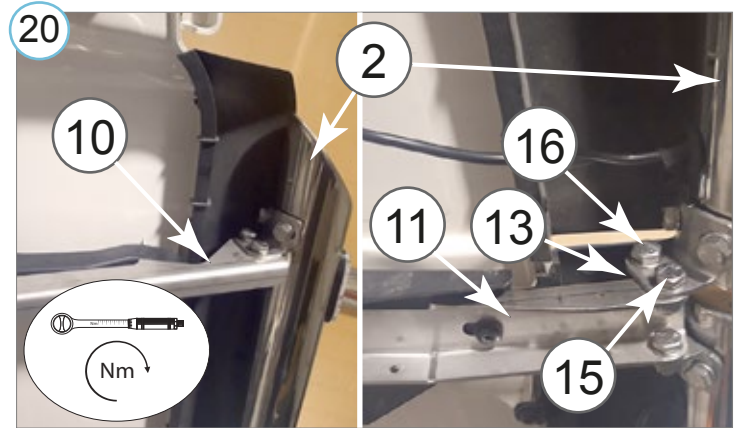
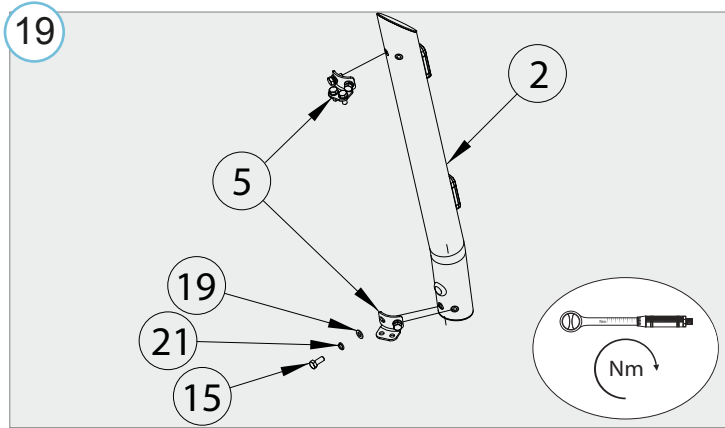
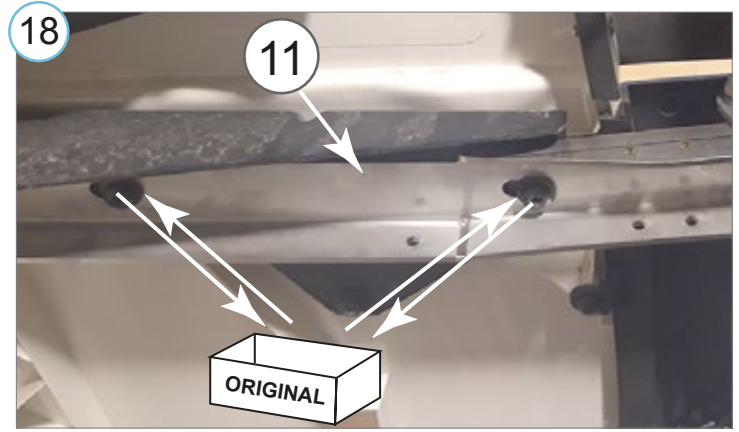
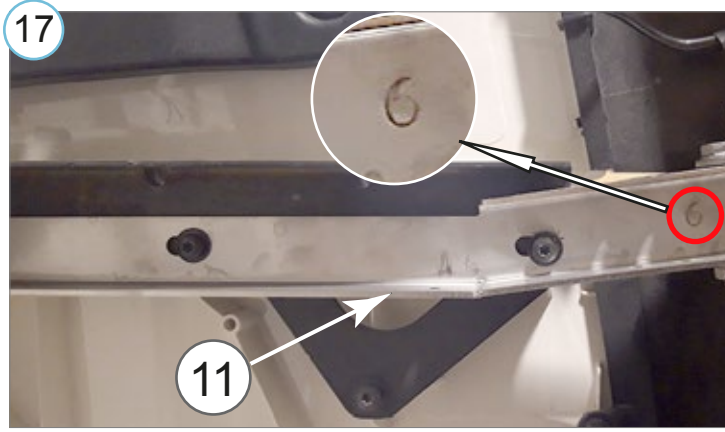

- Kui METEC toode ei vasta Teie ootustele või kui on tegemist toote ebapiisava kvaliteediga, siis pretensioonid esitada lehel www.metec.ee
- If the METEC product does not meet Your expectations or if it is a product of insufficient quality, then you can submit a claim at www.metec.ee
- Если METEC продукт не соответствует Вашим ожиданиям или это продукт недостаточного качества, то претензию предъявить можно на сайте www.metec.ee
- Wenn METEC Produkt nicht Ihren Erwartungen entspricht oder wenn es um Qualitätsmängel geht, dann bitte die Ansprüche auf Seite www.metec.ee einreichen

Lisa / extra / приложение / Extra

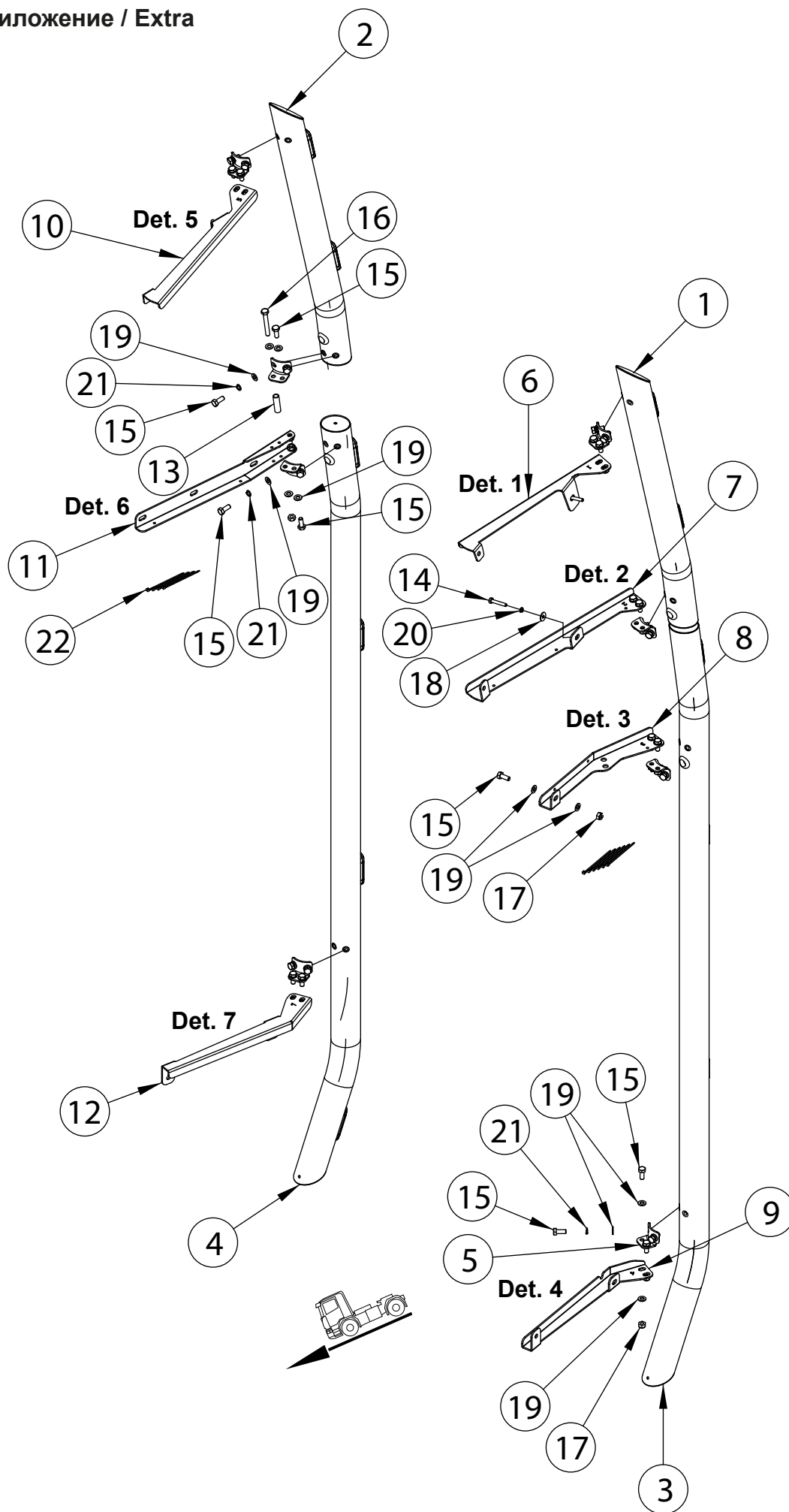

Scania R 2016- (high cabin)

Reelingud, külgmised | Railings, side | Перила, боковые | Geländer, Seite

Lisa / extra / приложение / Extra

