

MAN TG-S 2007- M&L cab, MAN TG-X 2007- XL cab

Ø70mm

1. lamp holder	1	6. bracket	2	11. bolt M8x40	2	16. washer 8,4x24x2	4
2. bracket	1	7. bushing	2	12. bolt M8x75	2	17. spring washer 8	8
3. bracket	1	8. compensator M8	2	13. nut M6	2		
4. clamp	6	9. bolt M6x20	2	14. nut M8	2		
5. clamp	6	10. bolt M8x20	4	15. washer 6,4x12x1,6	4		



M6 - 11Nm
M8 - 25Nm

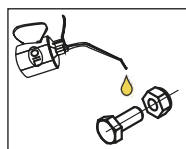

Poids : 10,7 Kg

Temps de montage : 45 min

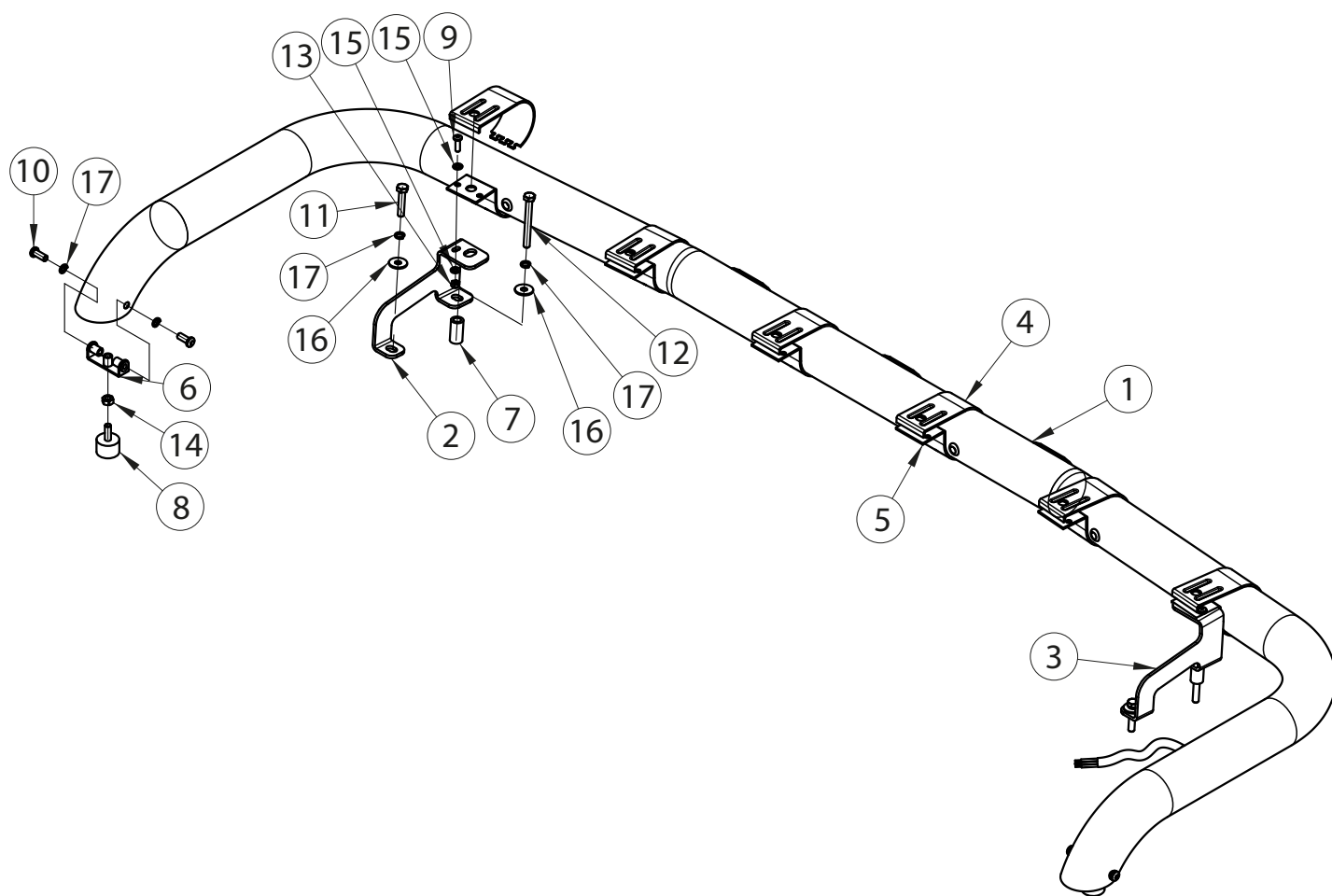

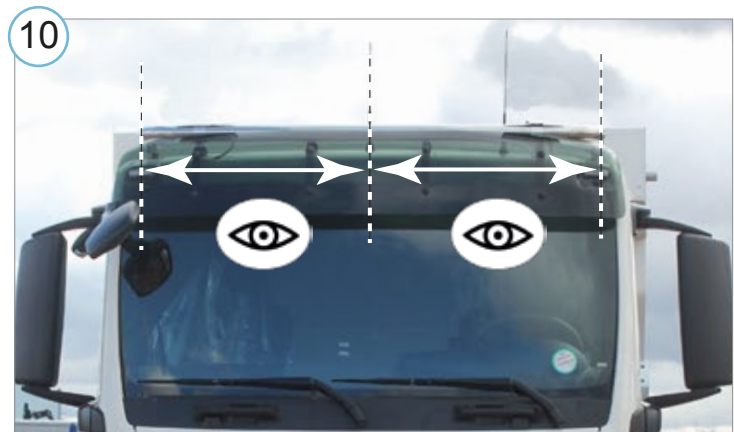
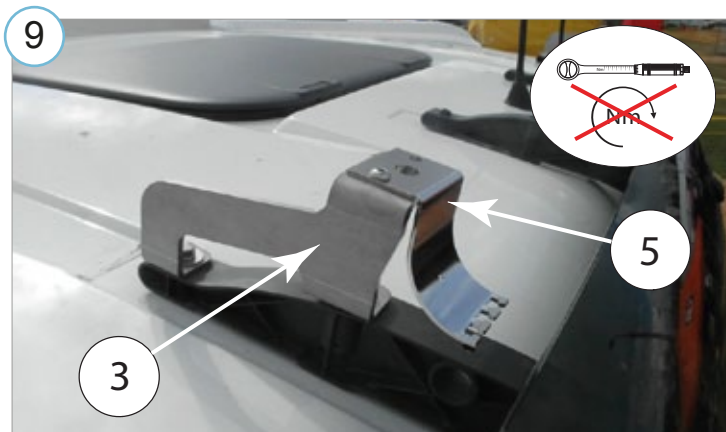
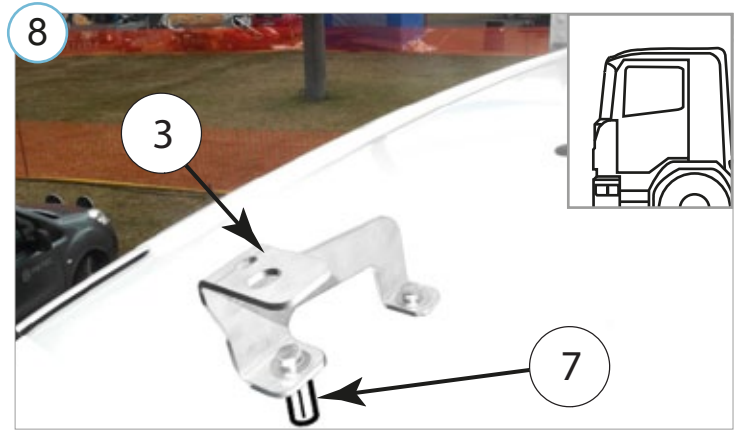
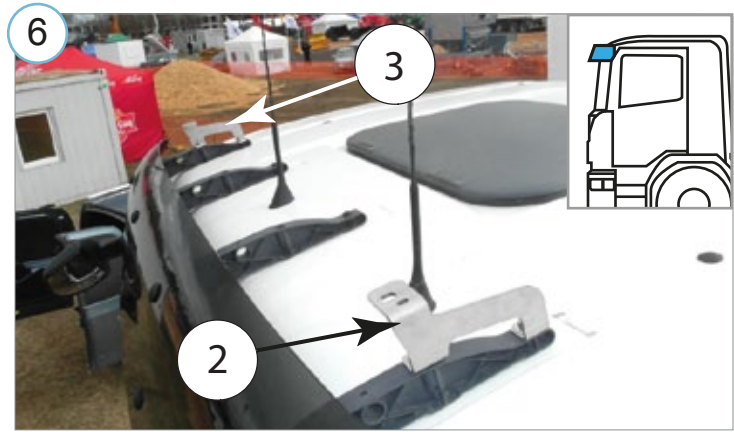
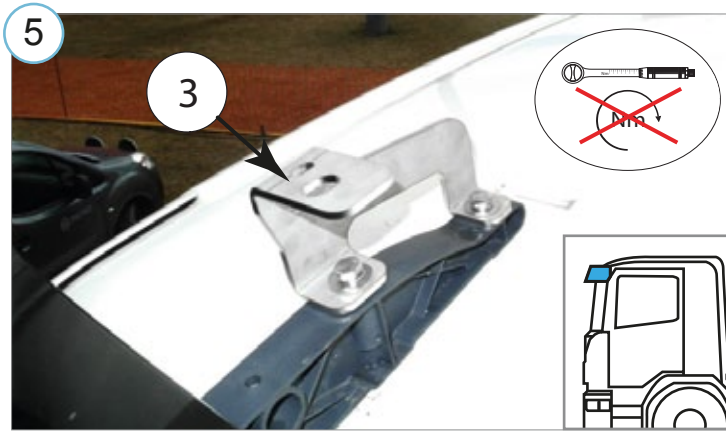
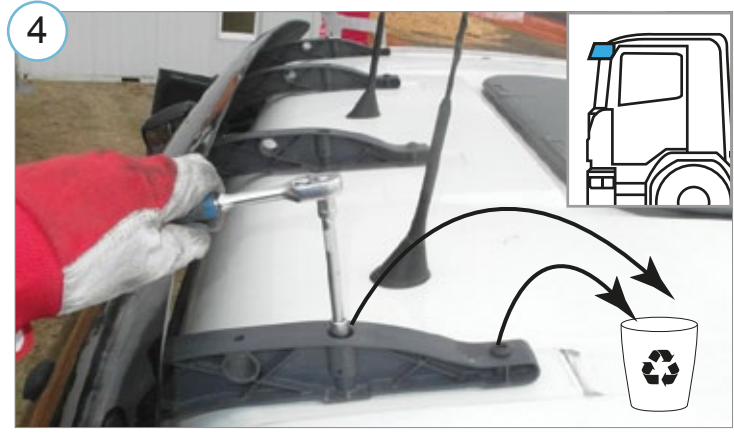
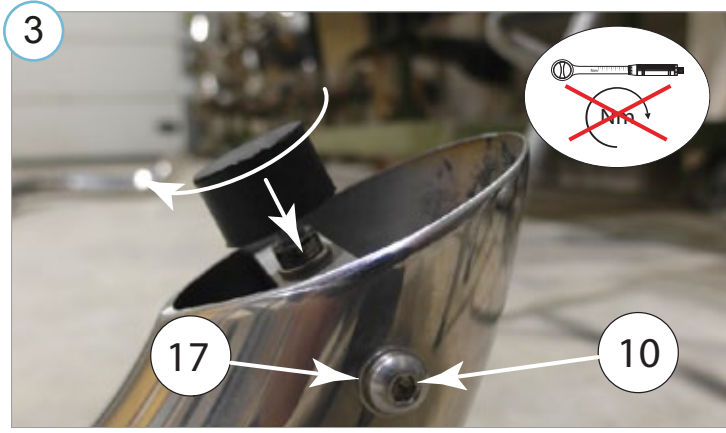



Install lamps

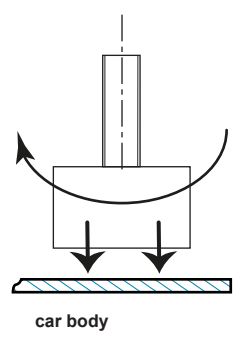
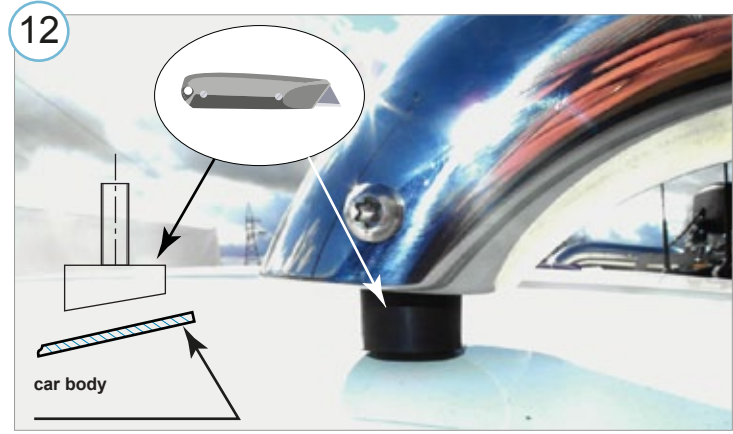

Screw compensator firmly against the car body

