



MAN TGX HIGH 2020-

Art. 854692, 854693-LED

Laternakandur MAX | Lamp holder MAX | Носител фар MAX | Scheinwerferbügel MAX

1. Klamber / clamp / зажим / Schelle
2. Brace-it paigaldamise abivahend / Brace-it installation tool / Инструмент для установки Brace-it / Brace-it-Installationswerkzeug
3. Vinkel / angled plate / угольник / winkel
4. Kompensaator / compensator / компенсатор / Kompensator
5. Kummiseib / rubber washer / резиновая шайба / Gummisscheibe d=30/15
6. Tihend / gasket / прокладка / Dichtung
7. Kruvi / screw / винт / Schraube 6x40
8. Polt / bolt / болт / Bolzen M8x30
9. Mutter / nut / гайка / Mutter M8
10. Seib / flat washer / шайба / Scheibe 6,6x22x2
11. Seib / flat washer / шайба / Scheibe 8,4x16x1,6
12. Seib / flat washer / шайба / Scheibe 8,4x24x2
13. Vedruseib / spring washer / пружинная шайба / Federnscheibe A8
14. Tõmbemutter / rivet nut / тяговая гайка / Nietmutter M8x13x21
15. Laternakandur / lamp holder / носитель фар / Scheinwerferbügel

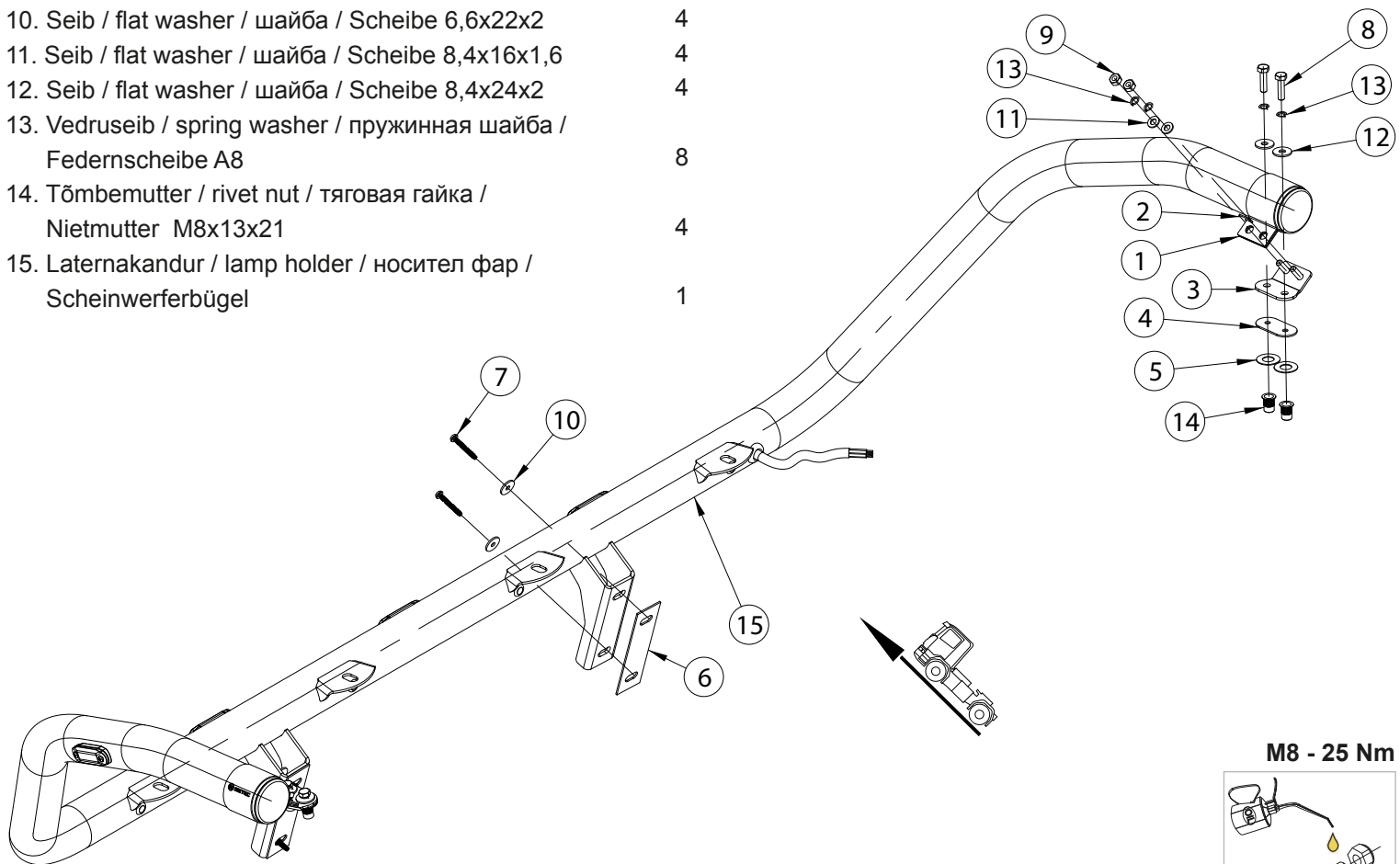

M8 - 25 Nm

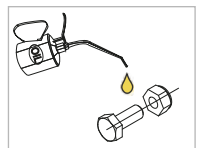

Kaal / Weight / Масса / Gewicht: 12 kg

Paigaldusaeg ilma elektritöödeta / Time of mounting w/o wiring works / Время установки без электромонт. работ / Einbauzeit ohne elektrische arbeit: 60 min

Vajalikud tööriistad / Required Tools / Необходимые инструменты / Benötigte Werkzeuge



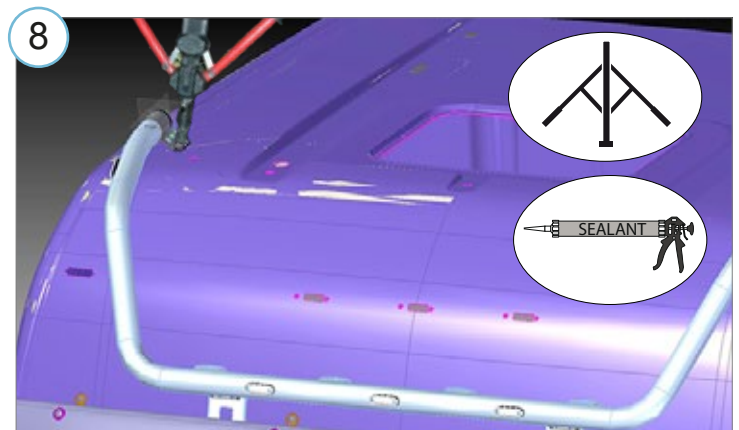
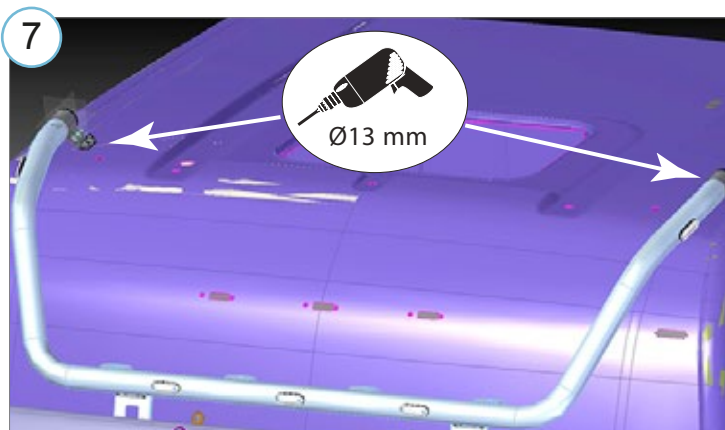
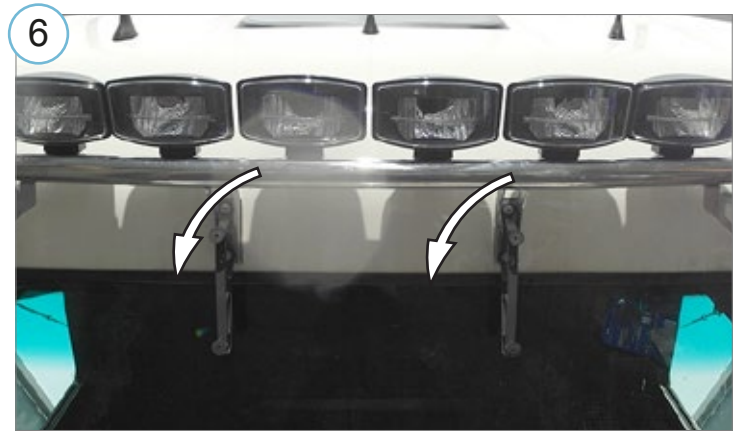
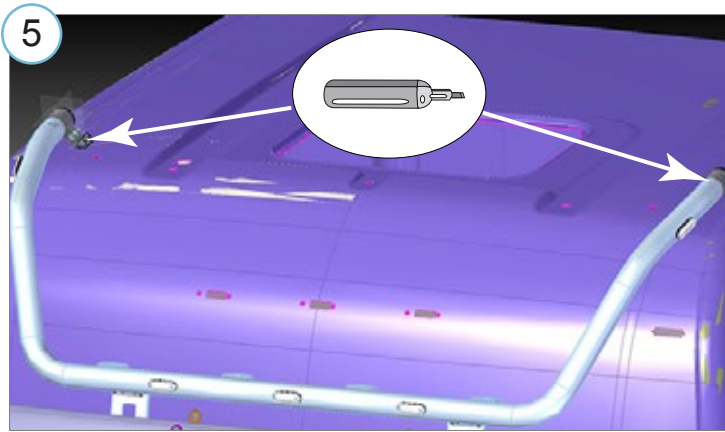
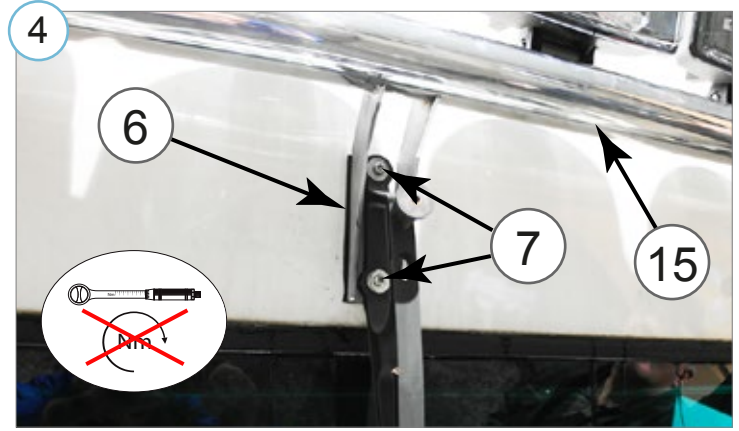
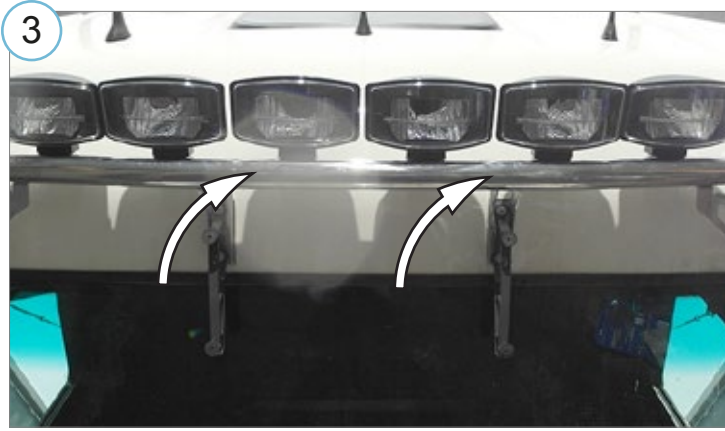
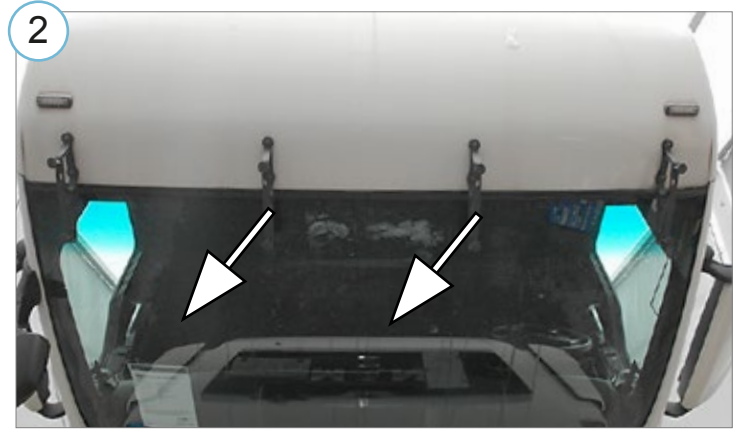
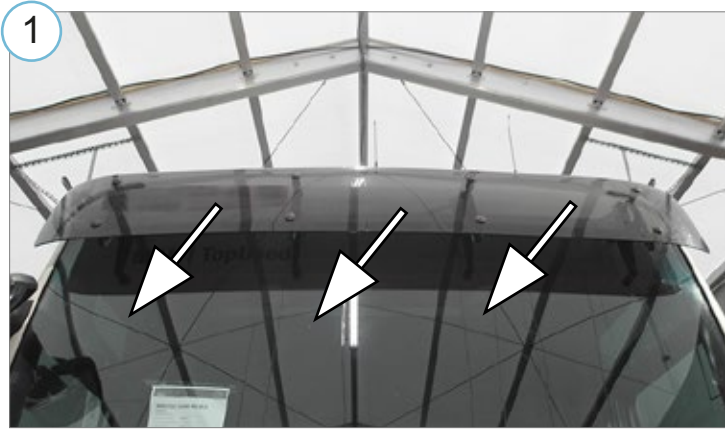

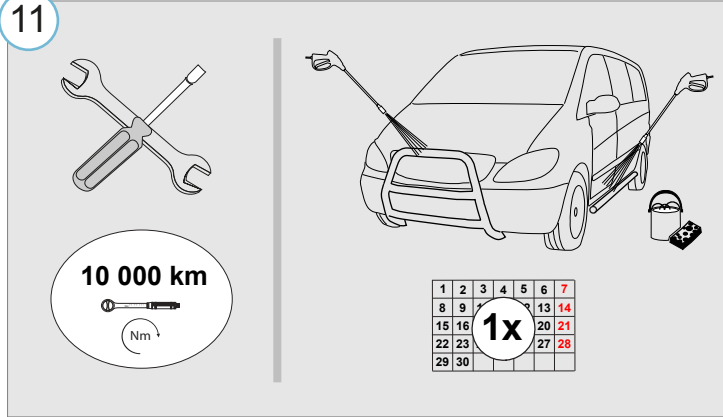
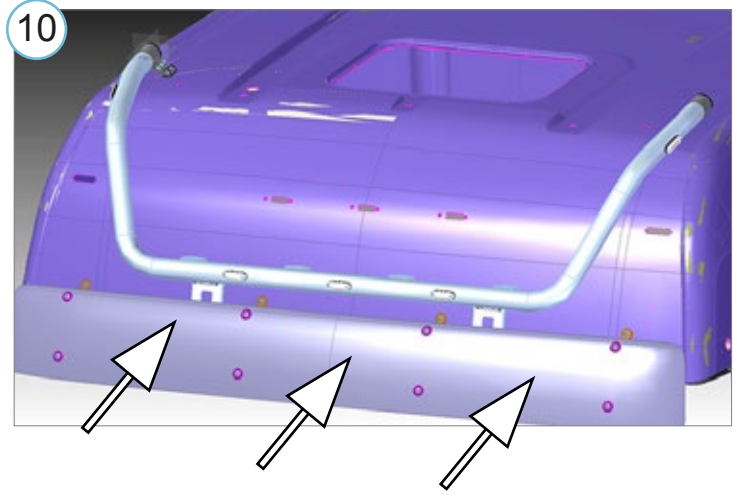
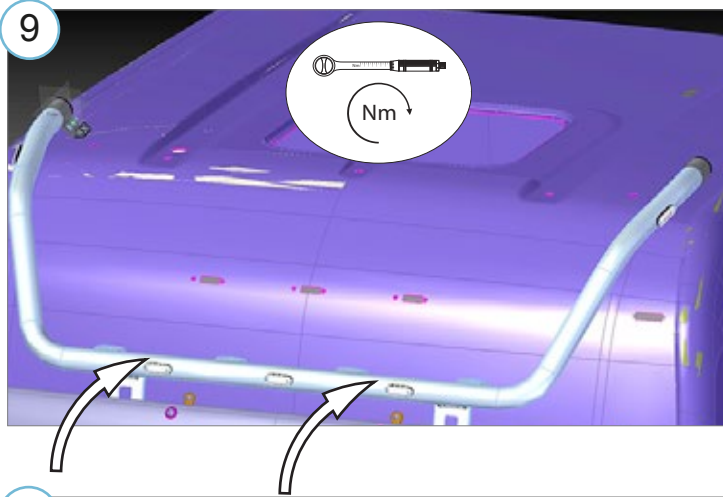

Switching pattern of the lights of the holder with 4 light connections. Led marker lights connected inside the tube. (if presented)

Juhul kui lampide A+B+C koguvõimsus ületab 280 W tuleb juhtmesarja võimalikke signaali juhtmeid (A/B) kasutada täiendavaks maanduseks! Erinevate laternate võimalik samaaegsete lülituste arv väheneb.

If the total wattage of the headlights A+B+C exceeds 280 W, the signal cables of the wiring harness (A/B) must be used as additional grounding! The number of possible simultaneous switching of different headlamps is decreasing.

Если общая мощность фар A+B+C превышает 280 Вт, сигнальные кабели жгута проводов (A/B) следует использовать в качестве дополнительного заземления! Количество возможных одновременных переключений различных фар уменьшается.

Falls die Gesamtleistung der Scheinwerfer A+B+C 280 W übersteigt, sind die eventuellen Signalkabel des Kabelbaums (A/B) als zusätzliche Erdung zu verwenden! Die Anzahl möglicher gleichzeitiger Schaltungen verschiedener Scheinwerfer verringert sich.

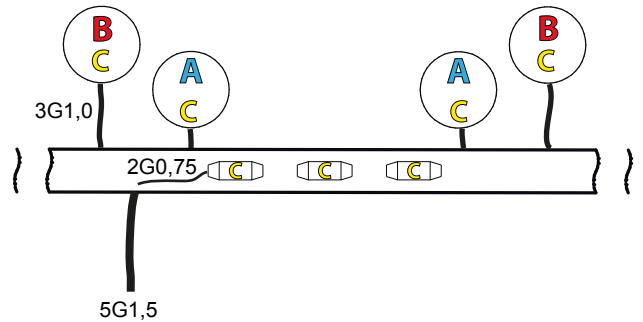

possible switch ON position	Harness ID number references / Juhtmesarjade viited			
	5G1,5	3G1,0 B	3G1,0 A	2G0,75
C+	1	1	1	2
A - C-	Gr/y	Gr/y		1
B+	2		2	
A+	3	2		
B-	4		Gr/y	

• Kui METEC toode ei vasta Teie ootustele või kui on tegemist toote ebapiisava kvaliteediga, siis pretensioonid esitada lehel www.metec.ee
 • If the METEC product does not meet Your expectations or if it is a product of insufficient quality, then you can submit a claim at www.metec.ee
 • Если METEC продукт не соответствует Вашим ожиданиям или это продукт недостаточного качества, то претензию предъявить можно на сайте www.metec.ee
 • Wenn METEC Produkt nicht Ihren Erwartungen entspricht oder wenn es um Qualitätsmängel geht, dann bitte die Ansprüche auf Seite www.metec.ee einreichen