



MB Citan, MB Citan Tourer, MB T-class 2022 -; Renault Kangoo (N1&M1) 2022 -

Art. 818036

Stangeääris | Spoilerbar | Спойлербар | Spoilerbar



1. Look / arc / дуга / Bogen	1
2. Polditav kronstein / bolt bracket / кронштейн / Bolzenhalterung	2
3. Latt / bracket / кронштейн / Latte	1
4. Latt / bracket / кронштейн / Latte	1
5*. Kronstein / bracket / кронштейн / Konsole	1
6*. Kronstein / bracket / кронштейн / Konsole	1
7. Polt / bolt / болт / Bolzen M8x20	8
8. Polt / bolt / болт / Bolzen M8x25	4
9. Mutter / nut / гайка / Mutter M8 DIN934-galZn	4
10. Mutter / nut / гайка / Mutter M8 DIN985-A2	8
11. Seib / flat washer / шайба / Scheibe 8,4x16x1,6	12
12. Seib / flat washer / шайба / Scheibe 8,4x24x2	12
13. Vedruseib / spring washer / пружинная шайба / Federnscheibe A8	8
14**. Plaat / plate / пластина / Platte	1
15**. Kronstein / bracket / кронштейн / Konsole	1
16**. Kronstein / bracket / кронштейн / Konsole	1
17**. U-polt / U-bolt / U-болт / U-bolzen	2

* - for MB Citan, Renault Kangoo (N1)

** - for MB Citan Tourer, MB T-class, Renault Kangoo (M1)

M8 - 25 Nm

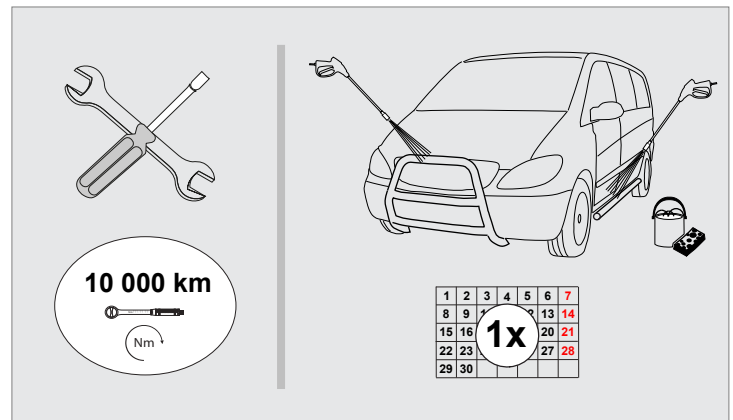
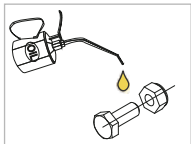

Kaal / Weight / Масса / Gewicht: 8,7 kg

Paigaldusaeg ilma elektritöödetä / Time of mounting w/o wiring works / Время установки без электромонт. работ / Einbauzeit ohne elektrische arbeit: 45 min

Vajalikud tööriistad / Required Tools / Необходимые инструменты / Benötigte Werkzeuge



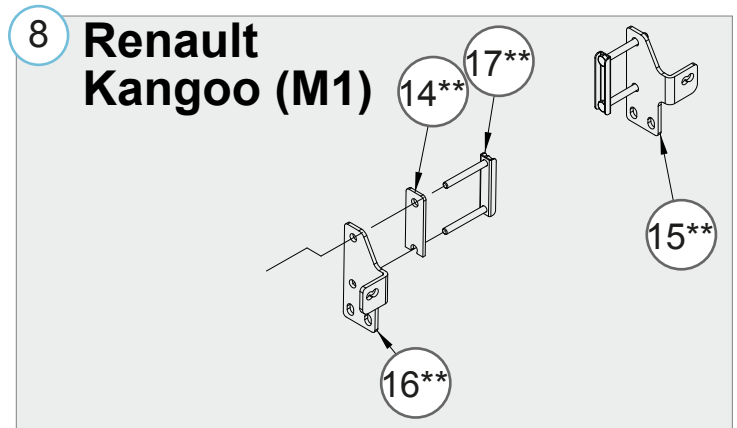
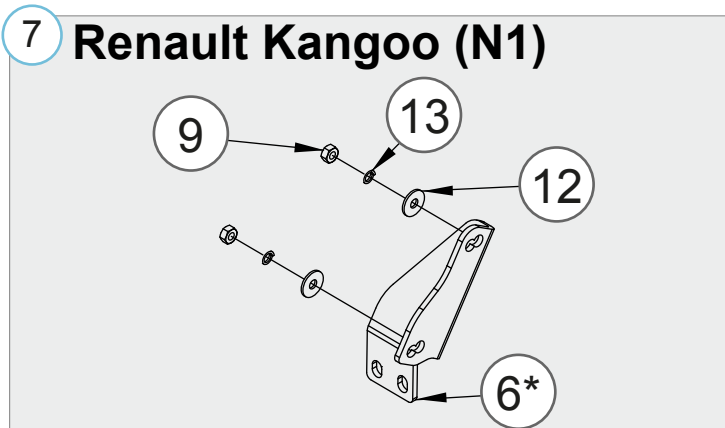
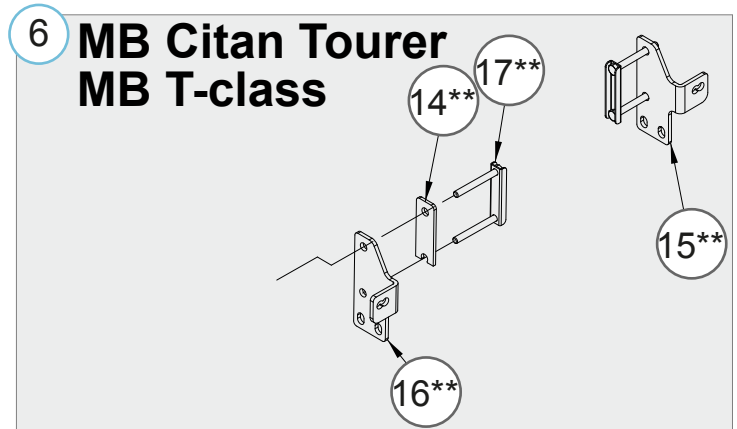
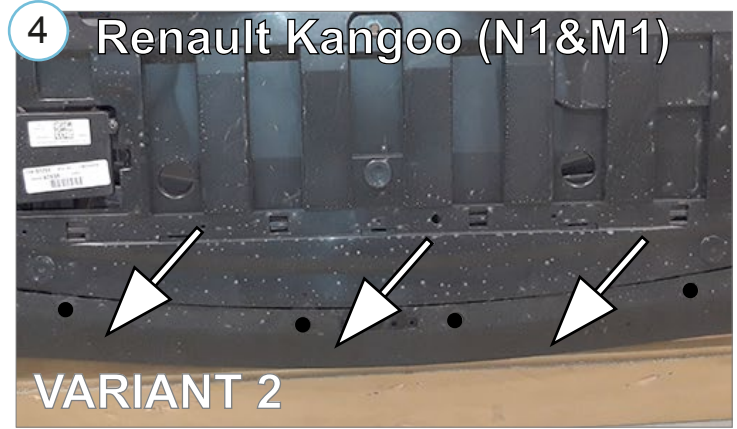
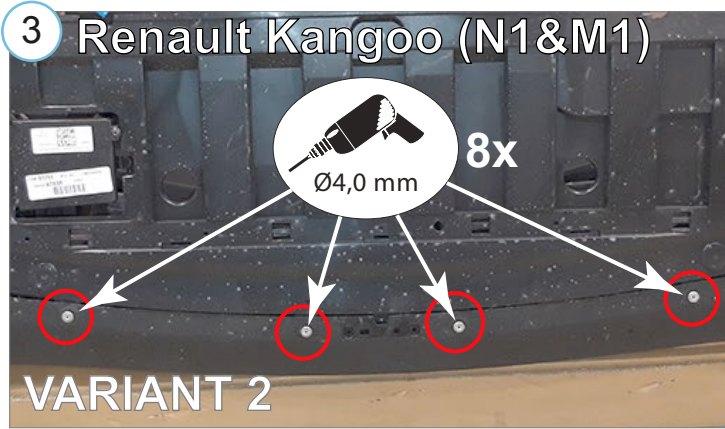
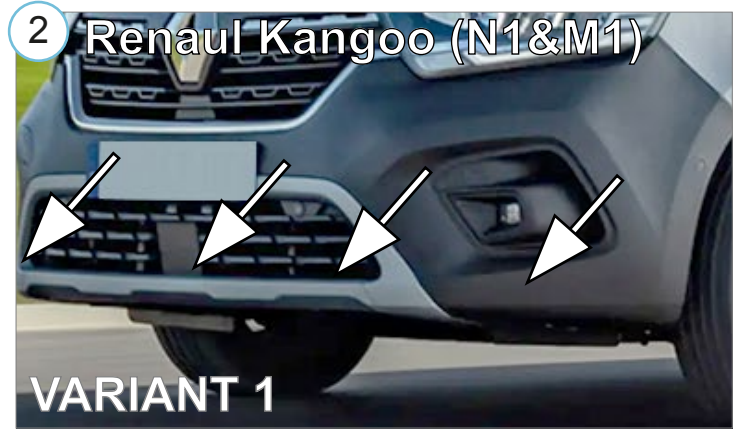

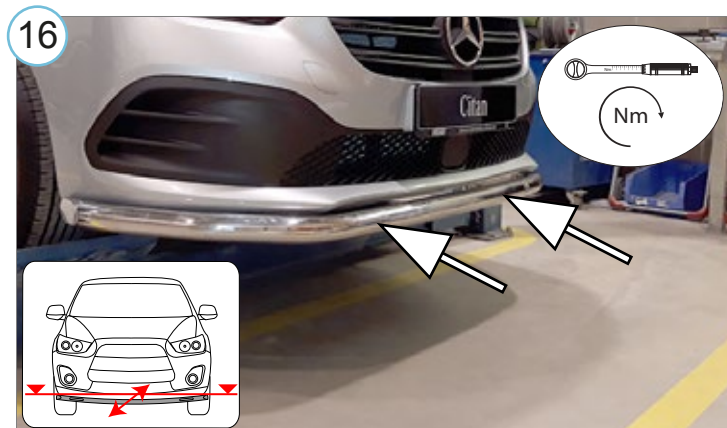
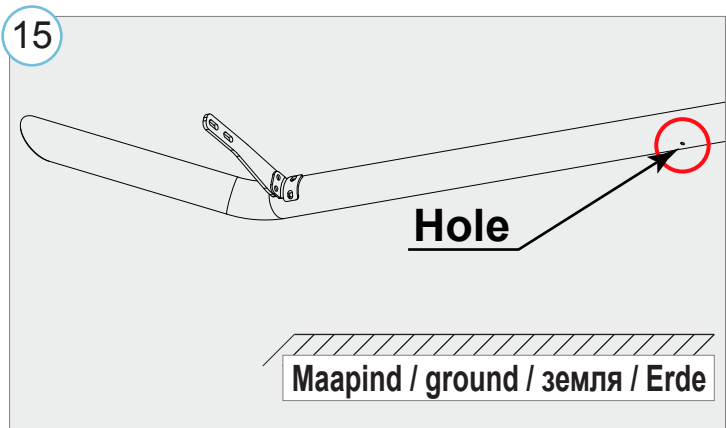
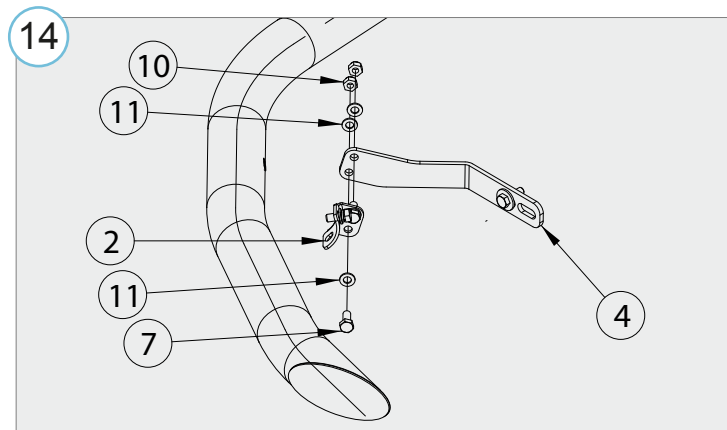
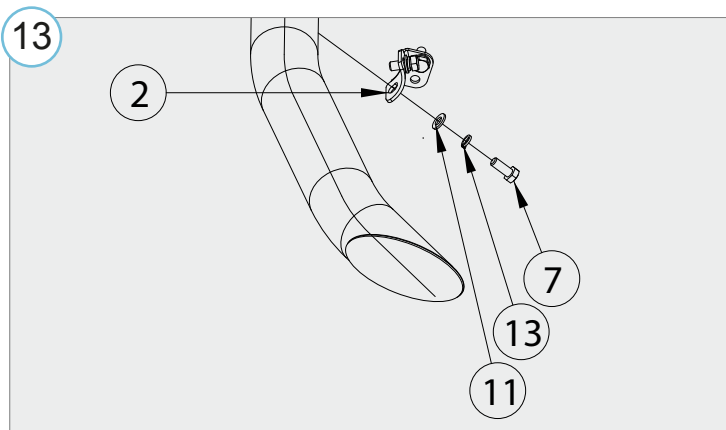
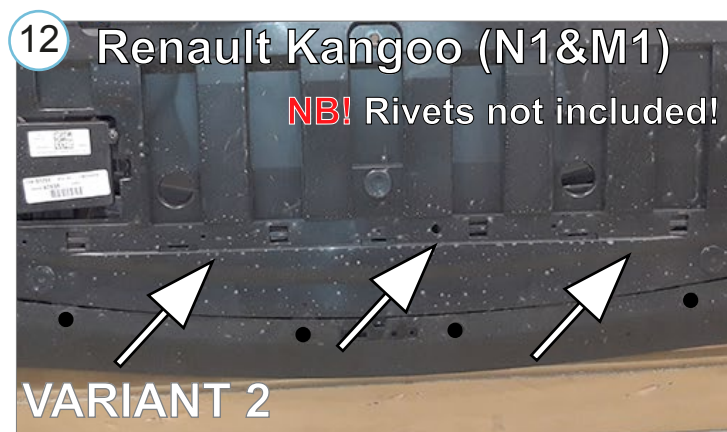
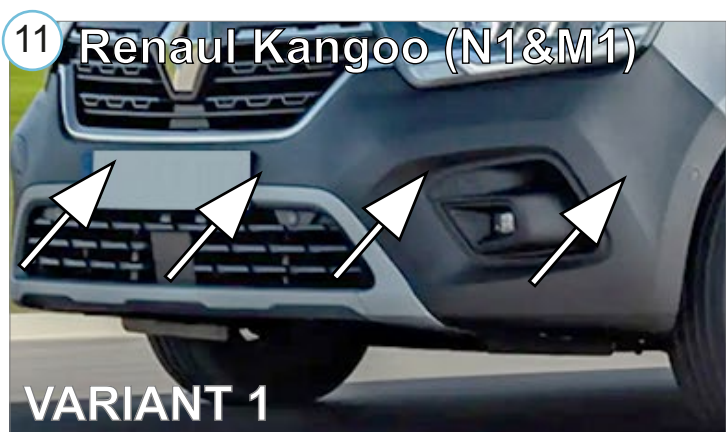
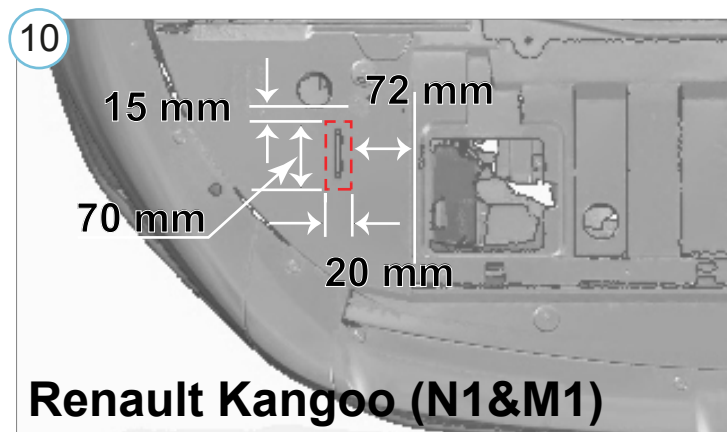
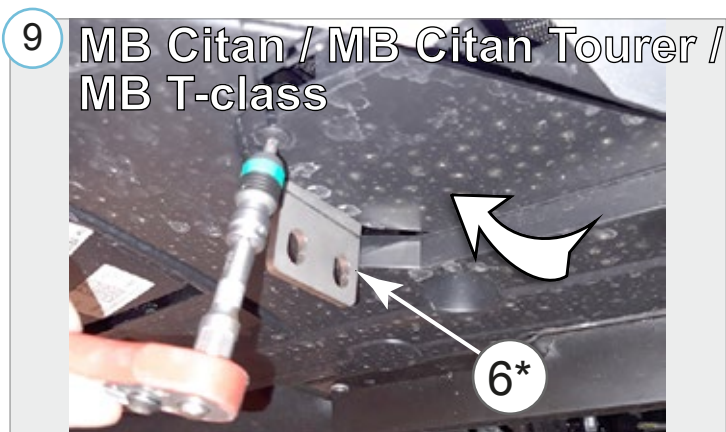

Lisa / extra / приложение / Extra

