



Montaažiskeem / Mounting Instructions / Монтажная схема

MB Actros 2011-

Art. 856590, 856592
Art. 856593

Küljetorud Ø 60

Sidebars Ø 60

Боковая труба Ø 60



- | | |
|--|-----|
| 1. Küljetoru/ sidebars / боковая труба | 1+1 |
| 2. Kronstein / bracket / кронштейн | 2 |
| 3. Kronstein / bracket / кронштейн | 2 |
| 4. Kaitseplekk/ heat reflector/ теплоотражатель | 1 |
| 5. Polt / bolt / болт M6x16 mm | 3 |
| 6. Polt / bolt / болт M8x25 mm | 8 |
| 7. Mutter / nut / гайка M6 DIN 934 | 3 |
| 8. Mutter / nut / гайка M8 DIN 933 | 8 |
| 9. Seib / washer / шайба 6,4x18x1,6 mm | 6 |
| 10. Seib / washer / шайба 8,4x24x2 mm | 16 |
| 11. Vedruseib / spring washer / пружинная шайба A6 | 3 |

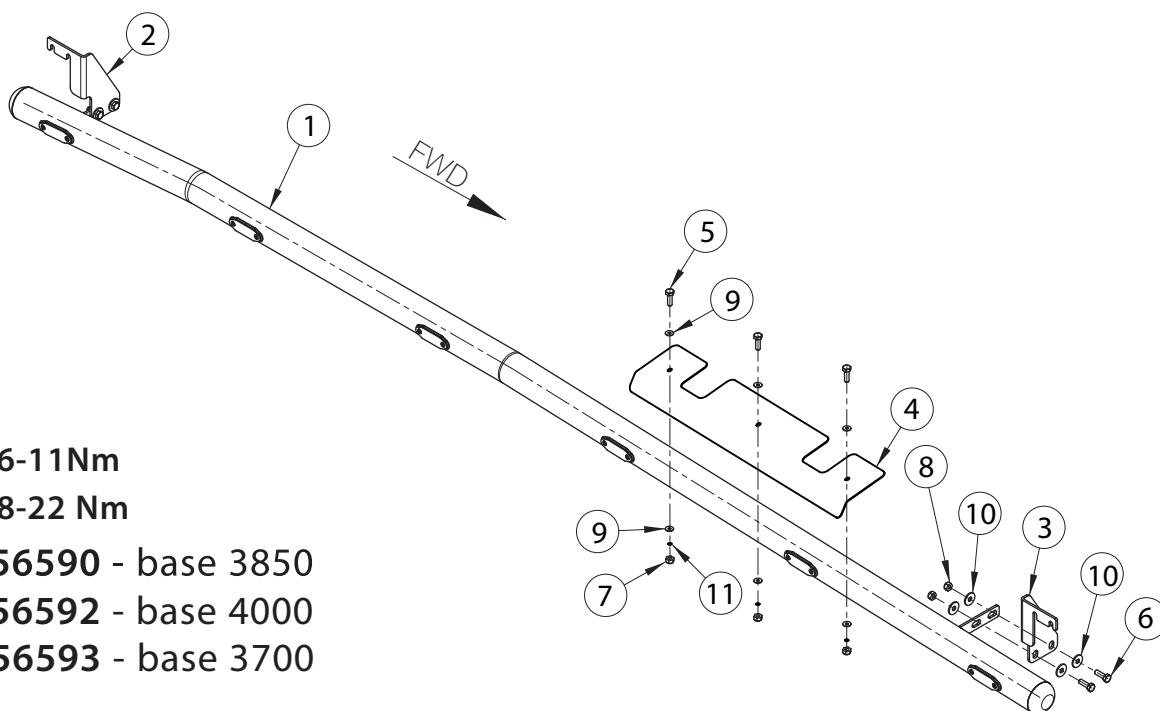

M6-11Nm

M8-22 Nm

856590 - base 3850

856592 - base 4000

856593 - base 3700

Vajalikud tööriistad / Required Tools / Необходимые инструменты



Montaažiskeem / Mounting Instructions / Монтажная схема

MB Actros 2011-

Art. 856590, 856592
Art. 856593

Küljetorud Ø 60

Sidebars Ø 60

Боковая труба Ø 60

Raigaldamine / Instructions / Инструкция установки

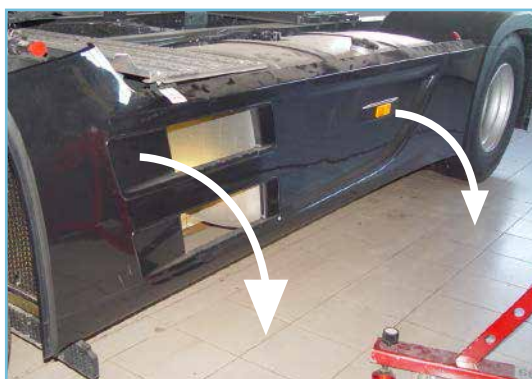

Pilt 1 / Pic. 1 / Рис. 1



Pilt 2 / Pic. 2 / Рис. 2



Pilt 3 / Pic. 3 / Рис. 3



Pilt 4 / Pic. 4 / Рис. 4

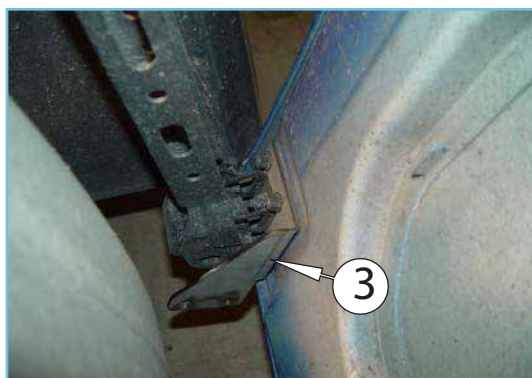

Pilt 5 / Pic. 5 / Рис. 5

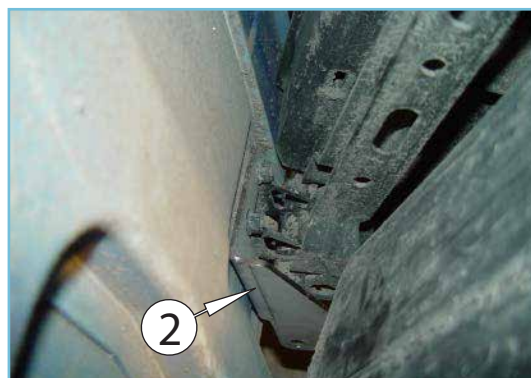

Pilt 6 / Pic. 6 / Рис. 6

Montaažiskeem / Mounting Instructions / Монтажная схема

MB Actros 2011-

Art. 856590, 856592
Art. 856593

Küljetorud Ø 60

Sidebars Ø 60

Боковая труба Ø 60

Raigaldamine / Instructions / Инструкция установки



Pilt 7 / Pic. 7 / Рис. 7

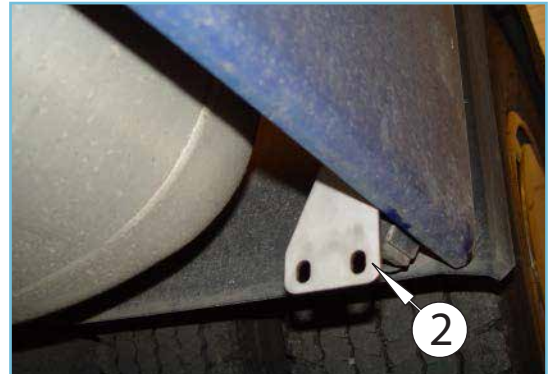

Pilt 8 / Pic. 8 / Рис. 8

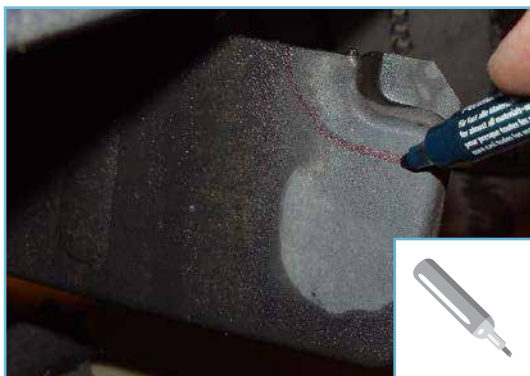

Pilt 9 / Pic. 9 / Рис. 9



Pilt 10 / Pic. 10 / Рис. 10



Pilt 11 / Pic. 11 / Рис. 11

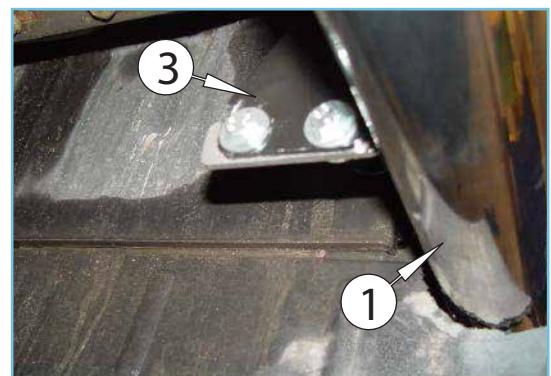

Pilt 12 / Pic. 12 / Рис. 12

Montaažiskeem / Mounting Instructions / Монтажная схема

MB Actros 2011-

Art. 856590, 856592
Art. 856593

Küljetorud Ø 60

Sidebars Ø 60

Боковая труба Ø 60

Paigaldamine / Instructions / Инструкция установки

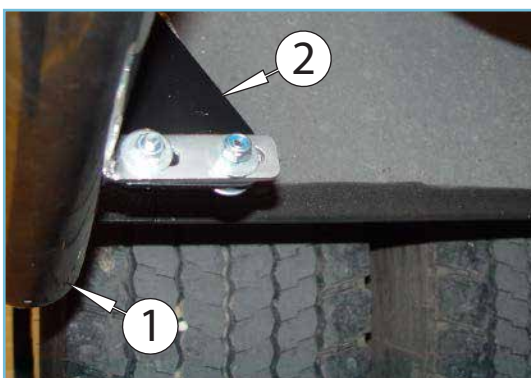

Pilt 13 / Pic. 13 / Рис. 13

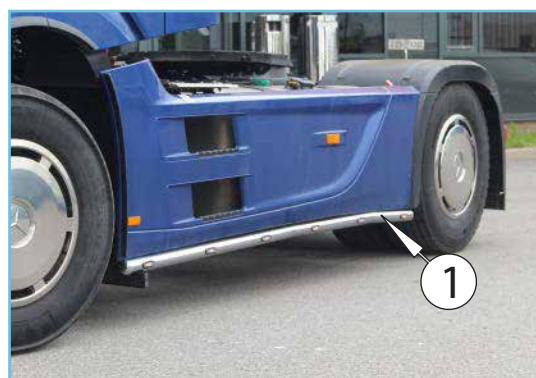

Pilt 14 / Pic. 14 / Рис. 14

Toote andmed / Data of the product / Данные о товаре

- Mõõdud / Measures / Размеры: 856590 - 2x(90x150x2585)mm; 856592 - 2x(90x150x2735)mm.
- Kaal / Weight / Масса: 856590 - 14,9 kg; 856592 - 15,2 kg 856593 - 13,9 kg
- Paigaldusaeg / Time of mounting / Время установки: 30 min.
- Tähtsad markeeringud / Important labels / Важные этикетки:

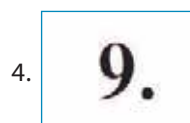

1. Komplekteerija number. / The number of the assembler / Номер комплектовщика
2. Tooteinfo pakendil / Product information on the package / Информация на упаковке
3. Tooteinfo tootel / Product information on the product / Информация на товаре
4. Kvaliteedi kontrolli tähis / Quality control number / Знак контроля качества