

Volvo FL 2006-2013 / FL 2024- / Renault D 2024-

Art. 868360

Laternakandur | Lamp holder | Scheinwerferbügel



- | | |
|---|----|
| 1. Laternakandur / lamp holder / Scheinwerferbügel | 1 |
| 2. Kronstein / bracket / Konsole | 1 |
| 3. Kronstein / bracket / Konsole | 1 |
| 4. Kronstein / bracket / Konsole | 1 |
| 5. Polditav kronstein / bolt bracket / Bolzenhalterung | 2 |
| 6. Laternaalus / lamp fixing bracket / Lampenbefestigung sklammer | 4 |
| 7. Põlt / bolt / Bolzen M8x20 DIN933-A2 | 14 |
| 8. Mutter / nut / Mutter M8 DIN985-A2 | 4 |
| 9. Seib / flat washer / Scheibe 8,4x16x1,6 | 14 |
| 10. Vedruseib / spring washer / Federnscheibe A8 | 10 |
| 11. Läbiviik / grommet / Tülle (for roof) | 1 |
| 12. Läbiviik / grommet / Tülle 13x21x26 (for sun visor) | 1 |

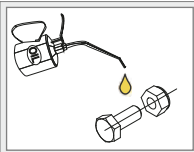
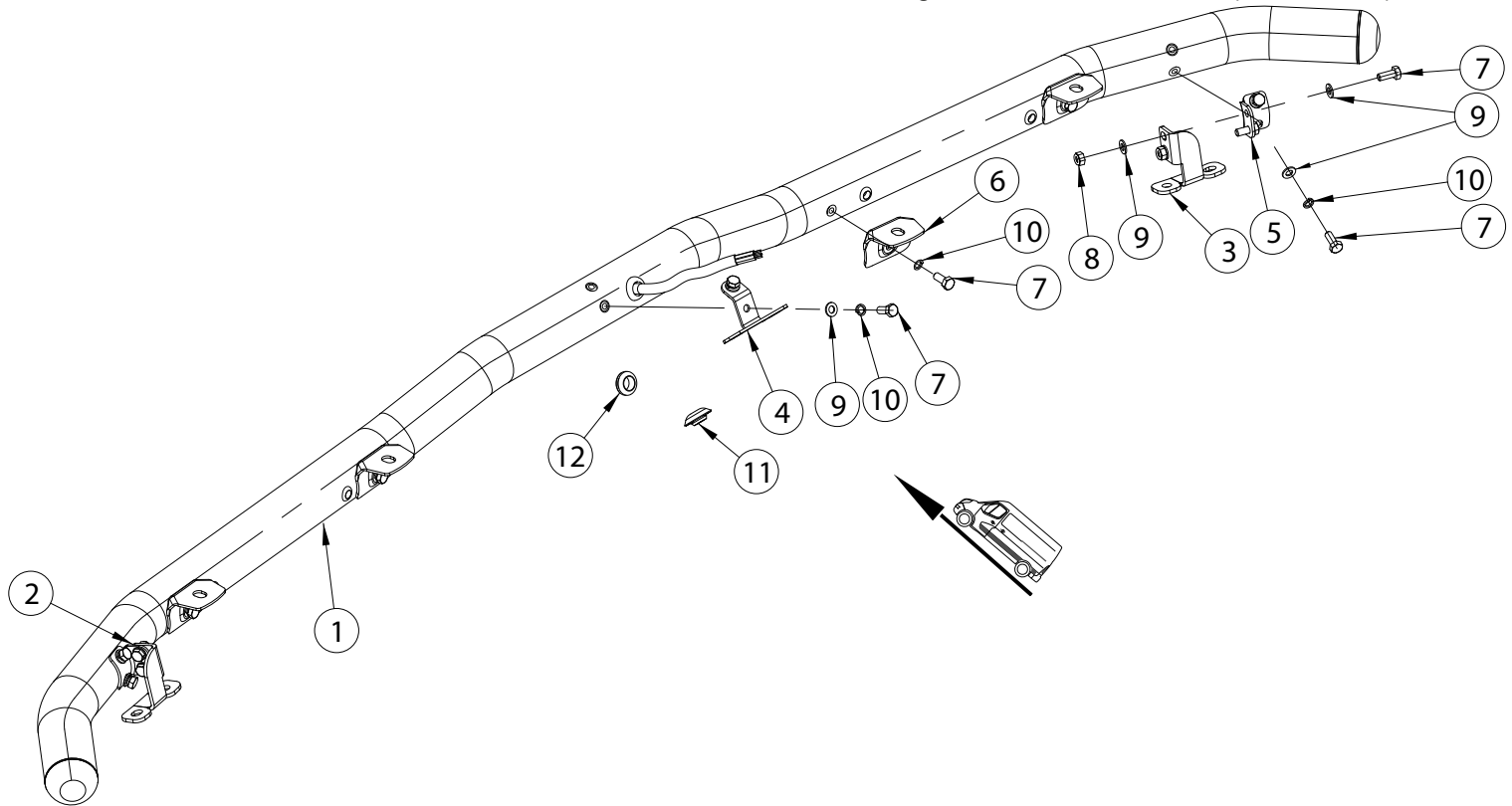

Külmeevituse vältimiseks kasutada külmeevitusvastast määret või mootoriõli.
To prevent cold welding, use cold weld grease or engine oil.
Verwenden Sie geeignetes Fett oder Motoröl, um die Kaltverschweißung zu verhindern.

Kaal / Weight / Gewicht: 8,3 kg

Paigaldusaeg ilma elektritöödeta / Time of mounting w/o wiring works / Einbauzeit ohne elektrische arbeit: 30 min

Vajalikud tööriistad / Required Tools / Benötigte Werkzeuge

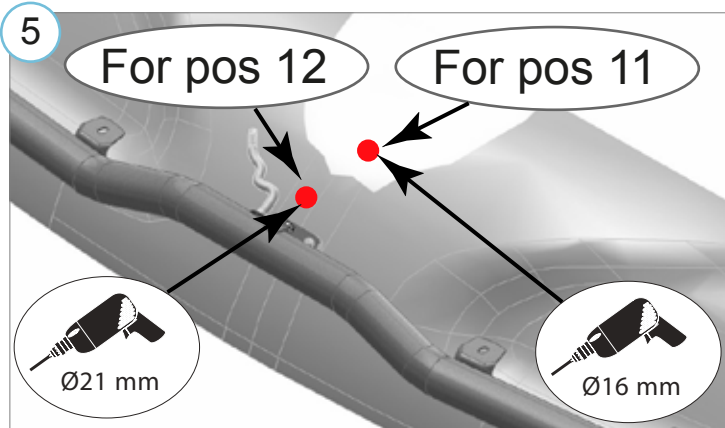
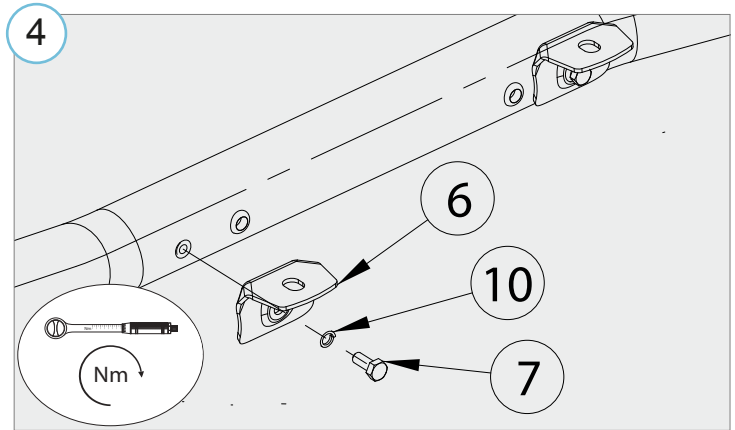
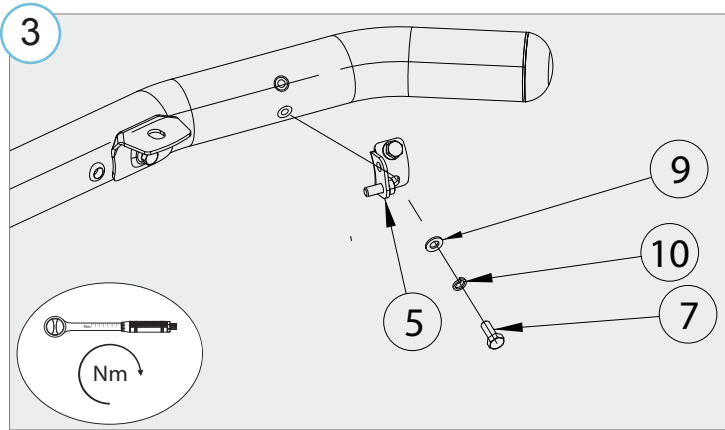
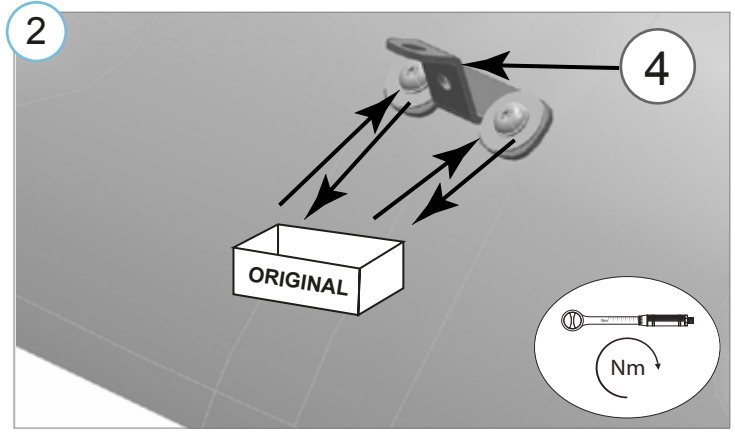
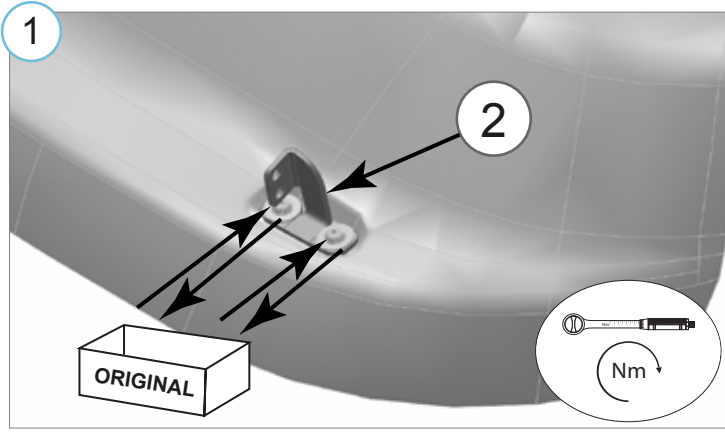
A2 / A4
M8 - 17 Nm





7

Elektriühendused teostada kvalifitseeritud autoelektriku pool

Installation of the lights can be carried out by qualified electrician only

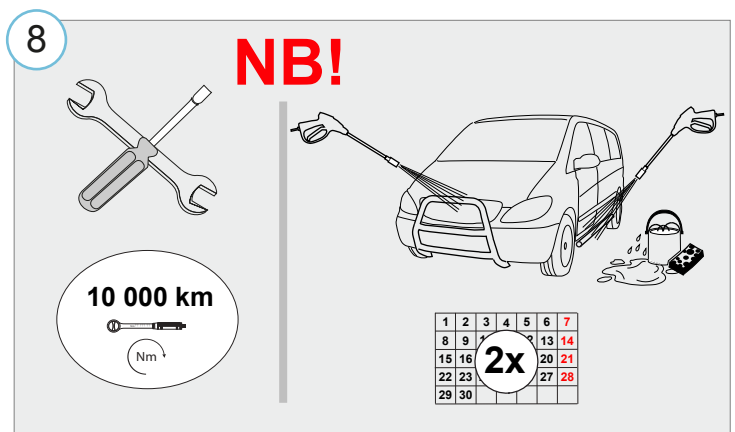
Die Installation der Lichter können durchgeführt werden durch Elektrofachkraft



• Kui METEC toode ei vasta Teie ootustele või kui on tegemist toote ebapiisava kvaliteediga, siis pretensioonid esitada lehel www.metec.ee
 • If the METEC product does not meet Your expectations or if it is a product of insufficient quality, then you can submit a claim at www.metec.ee
 • Wenn METEC Produkt nicht Ihren Erwartungen entspricht oder wenn es um Qualitätsmängel geht, dann bitte die Ansprüche auf Seite www.metec.ee einreiche